

HARMONY NEIGHBORHOOD 0-1

SECTION 29, TOWNSHIP 26 SOUTH, RANGE 32 EAST, OSCEOLA COUNTY, FLORIDA BEING A REPLAT OF TRACT M AND A PORTION OF TRACT L/U-2, HARMONY PHASE THREE, AS FILED AND RECORDED IN PLAT BOOK 20, PAGES 120 THRU 128 OF THE PUBLIC RECORDS OF OSCEOLA COUNTY, FLORIDA.

DEED RESTRICTIONS FOR THIS PLAT ARE FILED IN O.R. BOOK PAGE(S) AND (ARE) (ARE NOT) ACCOMPANIED BY DEED COVENANTS.

LEGAL DESCRIPTION

A PARCEL OF LAND LYING IN A PORTION OF SECTION 29, TOWNSHIP 26 SOUTH, RANGE 32 EAST, OSCEOLA COUNTY, FLORIDA.

BEING A REPLAT OF TRACT M AND A PORTION OF TRACT L/U-2, HARMONY PHASE THREE, AS FILED AND RECORDED IN PLAT BOOK 20, PAGES 120 THRU 128, OF THE PUBLIC RECORDS OF OSCEOLA COUNTY, FLORIDA.

BEING MORE PARTICULARLY DESCRIBED AS FOLLOWS:

BEGINNING AT THE NORTH-WEST CORNER OF TRACT "M", HARMONY PHASE THREE, AS FILED AND RECORDED IN PLAT BOOK 20, PAGES 120-128 OF THE PUBLIC RECORDS OF OSCEOLA COUNTY, FLORIDA, THENCE S53°04'04"E, A DISTANCE OF 17.50 FEET; THENCE S36°08'15"E, A DISTANCE OF 665.85 FEET; THENCE S10°16'01"W, A DISTANCE OF 57.90 FEET; THENCE S29°04'26"E, A DISTANCE OF 122.22 FEET; THENCE S46°21'17"E, A DISTANCE OF 144.45 FEET; THENCE S38°46'51"E, A DISTANCE OF 50.82 FEET; THENCE S13°55'49"E, A DISTANCE OF 107.05 FEET; THENCE S53°53'59"E, A DISTANCE OF 56.28 FEET; THENCE S23°36'16"E, A DISTANCE OF 67.37 FEET; THENCE S19°13'09"W, A DISTANCE OF 58.26 FEET; THENCE S03°41'20"E, A DISTANCE OF 8.82 FEET; THENCE S74°20'49"W, A DISTANCE OF 243.35 FEET; THENCE N41°54'01"W, A DISTANCE OF 16.81 FEET; THENCE N72°19'55"W, A DISTANCE OF 39.77 FEET; THENCE N79°48'26"W, A DISTANCE OF 36.89 FEET; THENCE S79°05'32"W, A DISTANCE OF 109.08 FEET; THENCE N70°21'00"W, A DISTANCE OF 15.64 FEET; THENCE N47°06'33"W, A DISTANCE OF 100.89 FEET; THENCE N65°39'47"W, A DISTANCE OF 130.19 FEET; THENCE S27°00'58"W, A DISTANCE OF 66.80 FEET; THENCE S28°46'58"W, A DISTANCE OF 46.07 FEET; THENCE S37°42'24"W, A DISTANCE OF 34.41 FEET; THENCE S54°34'46"W, A DISTANCE OF 49.93 FEET; THENCE S12°18'42"E, A DISTANCE OF 63.33 FEET; THENCE S22°47'19"W, A DISTANCE OF 23.06 FEET; THENCE S27°32'41"W, A DISTANCE OF 44.39 FEET; THENCE S02°03'37"W, A DISTANCE OF 70.07 FEET; THENCE S35°03'37"E, A DISTANCE OF 68.11 FEET; THENCE N85°18'39"E, A DISTANCE OF 86.45 FEET; THENCE N89°41'49"E, A DISTANCE OF 165.73 FEET; THENCE N88°08'32"E, A DISTANCE OF 47.24 FEET; THENCE S50°17'14"E, A DISTANCE OF 50.92 FEET; THENCE S62°28'20"E, A DISTANCE OF 68.64 FEET; THENCE S58°13'37"E, A DISTANCE OF 15.82 FEET; THENCE S01°3'23"E, A DISTANCE OF 76.82 FEET; THENCE S38°26'32"W, A DISTANCE OF 17.13 FEET; THENCE S82°27'25"W, A DISTANCE OF 56.28 FEET; THENCE N75°54'23"W, A DISTANCE OF 141.85 FEET; THENCE S64°05'32"W, A DISTANCE OF 139.84 FEET; THENCE N83°23'27"W, A DISTANCE OF 62.83 FEET; THENCE N65°47'25"W, A DISTANCE OF 62.46 FEET; THENCE S14°00'44"W, A DISTANCE OF 78.12 FEET; THENCE S28°19'08"E, A DISTANCE OF 61.62 FEET; THENCE S09°16'16"E, A DISTANCE OF 80.25 FEET; THENCE S33°58'17"E, A DISTANCE OF 66.15 FEET; THENCE S47°06'46"W, A DISTANCE OF 46.24 FEET; THENCE S60°14'54"W, A DISTANCE OF 82.18 FEET; THENCE S62°34'35"W, A DISTANCE OF 83.81 FEET; THENCE S73°01'43"W, A DISTANCE OF 86.77 FEET; THENCE N85°11'37"W, A DISTANCE OF 31.26 FEET; THENCE N01°33'32"E, A DISTANCE OF 18.49 FEET; THENCE N58°04'01"E, A DISTANCE OF 24.05 FEET; THENCE N76°59'18"E, A DISTANCE OF 51.51 FEET; THENCE N77°06'25"E, A DISTANCE OF 66.43 FEET; THENCE N32°56'33"E, A DISTANCE OF 130.10 FEET; THENCE N19°14'19"W, A DISTANCE OF 17.28 FEET; THENCE N08°46'34"W, A DISTANCE OF 51.94 FEET; THENCE N56°29'32"W, A DISTANCE OF 121.23 FEET; THENCE N81°18'01"W, A DISTANCE OF 53.19 FEET; THENCE S17°44'16"W, A DISTANCE OF 68.15 FEET; THENCE S11°51'05"W, A DISTANCE OF 61.22 FEET; THENCE N47°56'14"W, A DISTANCE OF 98.94 FEET; THENCE N28°09'40"W, A DISTANCE OF 34.69 FEET; THENCE N32°24'48"W, A DISTANCE OF 59.13 FEET; THENCE N16°32'17"W, A DISTANCE OF 44.54 FEET; THENCE N36°56'11"W, A DISTANCE OF 105.20 FEET; THENCE N29°41'14"W, A DISTANCE OF 45.54 FEET; THENCE N17°07'40"W, A DISTANCE OF 35.94 FEET; THENCE N08°12'01"E, A DISTANCE OF 64.11 FEET; THENCE N06°19'02"W, A DISTANCE OF 40.88 FEET; THENCE N10°44'56"E, A DISTANCE OF 77.39 FEET; THENCE N53°28'47"W, A DISTANCE OF 50.32 FEET; THENCE N09°37'09"E, A DISTANCE OF 35.08 FEET; THENCE N36°00'30"E, A DISTANCE OF 33.16 FEET; THENCE N39°15'41"W, A DISTANCE OF 72.29 FEET; THENCE N64°18'47"W, A DISTANCE OF 70.42 FEET; THENCE S49°11'49"W, A DISTANCE OF 55.21 FEET; THENCE N56°54'06"W, A DISTANCE OF 1.13 FEET; THENCE N34°28'04"E, A DISTANCE OF 56.42 FEET; THENCE S55°33'53"E, A DISTANCE OF 8.00 FEET; THENCE N34°28'03"E, A DISTANCE OF 147.83 FEET; THENCE N55°31'56"W, A DISTANCE OF 14.50 FEET; THENCE N34°28'03"E, A DISTANCE OF 50.00 FEET; THENCE S55°31'56"E, A DISTANCE OF 14.50 FEET; THENCE N34°28'03"E, A DISTANCE OF 252.29 FEET, TO A POINT OF CURVE TO THE LEFT HAVING A RADIUS OF 1,579.00 FEET AND A CENTRAL ANGLE OF 05°28'48"; THENCE NORTHEASTERLY ALONG THE ARC, A DISTANCE OF 151.02 FEET; THENCE N28°59'15"E, A DISTANCE OF 387.45 FEET; THENCE N61°00'45"W, A DISTANCE OF 14.50 FEET; THENCE N28°59'15"E, A DISTANCE OF 50.00 FEET; THENCE S61°00'45"E, A DISTANCE OF 14.50 FEET; THENCE N28°59'15"E, A DISTANCE OF 92.29 FEET, TO A POINT OF CURVE TO THE LEFT HAVING A RADIUS OF 1,500.00 FEET AND A CENTRAL ANGLE OF 05°55'12"; THENCE NORTHEASTERLY ALONG THE ARC A DISTANCE OF 154.99 FEET TO THE POINT OF BEGINNING.

CONTAINING 26.33 ACRES, MORE OR LESS.

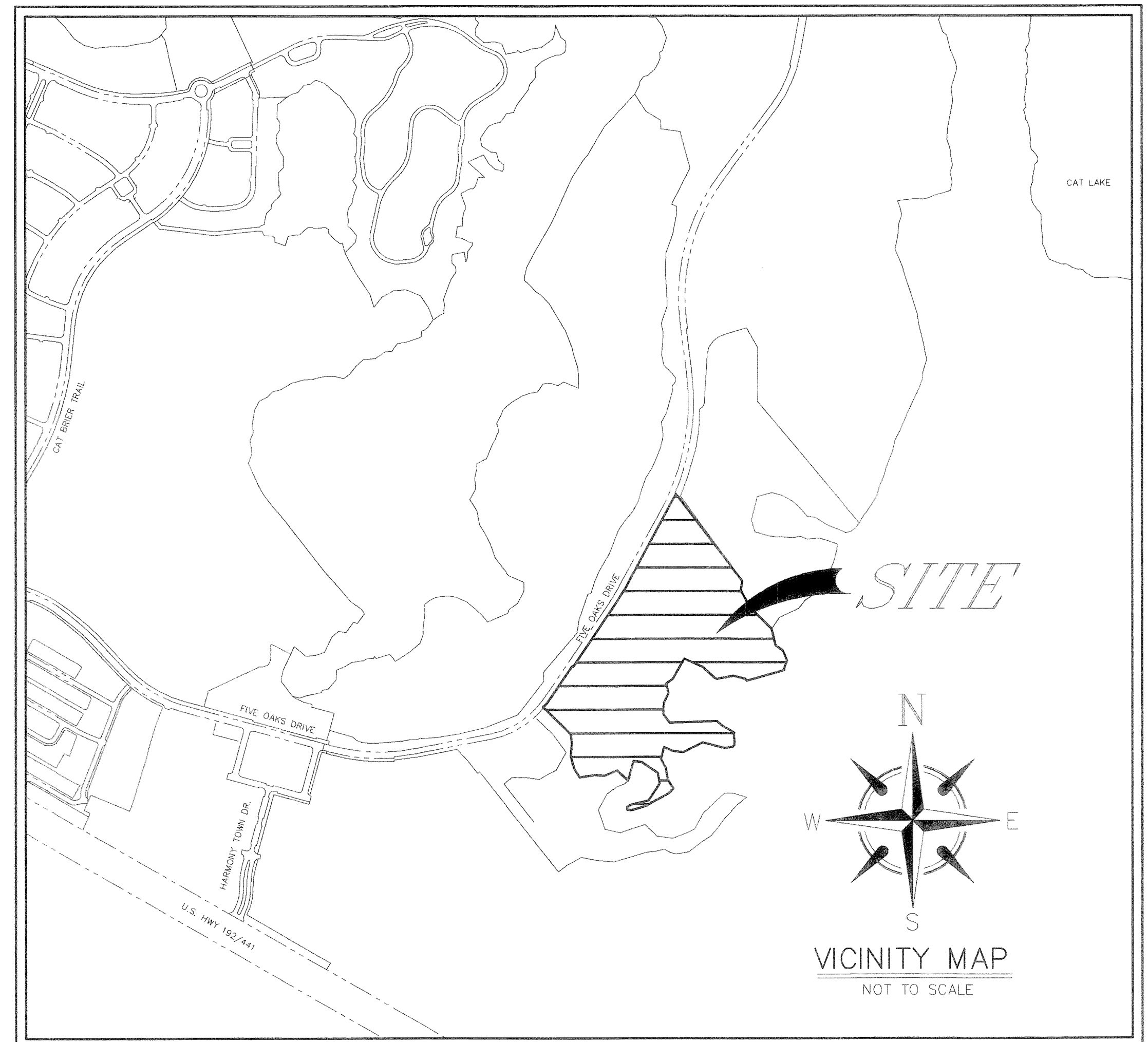

JOHNSTON'S SURVEYING INC 900 Shady Lane, Kissimmee, Florida 34744-8695 Tel. (407) 847-2179 Fax (407) 847-6140

\*THIS PLAT, AS RECORDED IN ITS GRAPHICAL FORM, IS THE OFFICIAL DEPICTION OF THE SUBDIVIDED LANDS DESCRIBED HEREIN AND WILL IN NO CIRCUMSTANCES BE SUPPLANTED IN AUTHORITY BY ANY OTHER GRAPHIC OR DIGITAL FORM OF THE PLAT. THERE MAY BE ADDITIONAL RESTRICTIONS THAT ARE NOT RECORDED ON THIS PLAT THAT MAY BE FOUND IN THE PUBLIC RECORDS OF THIS COUNTY.\*

DEDICATION HARMONY NEIGHBORHOOD 0-1

KNOW ALL BY THESE PRESENTS, that Birchwood Acres Limited Partnership, L.L.P., a Florida limited liability partnership, 1/4/6 Birchwood Acres Limited Partnership, a Florida limited partnership (the "Partnership") and the Harmony Community Development District, a limited special and single purpose local government according to Chapter 190, Florida Statutes (the "HCDD"), each being the owner in fee simple of a portion of the lands described in the foregoing caption to this plat and together owning all of such land hereby dedicate the said lands and plat for the uses and purposes herein expressed; dedicate the named streets (but only to the extent of the specific named portion of the right-of-way widths set forth herein) to the perpetual use of the public; dedicate the easements that are given herein to Osceola County, Florida ("County") (as grantee) to the perpetual use of the public; dedicate the easements that are given herein to the HCDD or the Partnership (as grantee) to the proper uses and purposes of the HCDD and Partnership; dedicate Tract 0-100, Tract 0-300 and Tract 0-600 to the perpetual use of the HCDD for open space and landscaping uses and purposes of the HCDD; and dedicate Tract 0-400 to the perpetual use of the HCDD for stormwater, drainage and open space uses and purposes of the HCDD. All other lands, tracts, road shoulders or easements shown on this plat are not dedicated to the public nor for any other public use or benefit. IN WITNESS WHEREOF, the Partnership has caused these presents to be signed and attested to or witnessed by the officers or individuals named below and the corporate seal of its general partner to be affixed hereto on the date set forth in the notary acknowledgment.

ADDRESS: 3500 Harmony Square Drive West, Harmony, Florida 34773

By: VII GP Harmony, L.L.C., a Delaware limited liability company, as its general partner Name: Michael Moser Title: Authorized Agent

Signed and sealed in the presence of: Attest: Robert Glantz, Authorized Agent

Jennifer LaFemina, Robert Glantz, Authorized Agent

STATE OF FLORIDA COUNTY OF OSCEOLA I HEREBY CERTIFY that on this 21 day of October 2016, before me, an officer duly authorized to take acknowledgments in the State and County aforesaid, personally appeared Michael Moser and Robert Glantz, who are personally known to me, each as an Authorized Agent of VII GP Harmony, L.L.C., a Delaware limited liability company, the general partner of Birchwood Acres Limited Partnership, L.L.P., a Florida limited liability partnership (1/4/6 Birchwood Acres Limited Partnership, a Florida limited partnership), who executed the foregoing Dedication and severally acknowledged the execution thereof to be of their free act and deed as such officers or authorized agents thereto duly authorized; that the official seal of VII GP Harmony, L.L.C., a Delaware limited liability company, is duly affixed thereto and that said Dedication is the act and deed of the Partnership.

IN WITNESS WHEREOF, I have hereunto set my hand and seal on the above date. NOTARY PUBLIC Lori E. Joyce, My Commission Expires 9/19/2019

HARMONY COMMUNITY DEVELOPMENT DISTRICT, A LIMITED SPECIAL AND SINGLE PURPOSE LOCAL GOVERNMENT CREATED BY CHAPTER 190, FLORIDA STATUTES AND ESTABLISHED BY COUNTY ORDINANCE

Signed and sealed in the presence of: Amber Sambuca, Chairman; Ralph Estrovez, Attest; Richard van der Suij

STATE OF Florida COUNTY OF Osceola The foregoing instrument was acknowledged before me this 25 day of October 2016 by Amber Sambuca, Chairman of the Harmony Community Development District, a limited special and single purpose local government created by Chapter 190, Florida Statutes and established by County ordinance. He/She is personally known to me or has produced as identification.

IN WITNESS WHEREOF, I have hereunto set my hand and seal on the above date. NOTARY PUBLIC Catherine M. Bordes, My Commission Expires September 25, 2018

CERTIFICATE OF APPROVAL BY COUNTY ENGINEER Examined and Approved: 12/7/2016

CERTIFICATE OF APPROVAL BY BOARD OF COUNTY COMMISSIONERS THIS IS TO CERTIFY, That on December 05, 2016 the foregoing plat was approved by the Board of County Commissioners of Osceola County, Florida

CERTIFICATE OF SURVEYOR KNOW ALL BY THESE PRESENTS, That the undersigned, being a licensed surveyor registered in the State of Florida, does hereby certify that on 09/20/2014 he completed the survey of the lands as shown in the fore-going plat; that said plat is a correct representation of the lands herein described and platted or subdivided; that permanent reference monuments have been placed as shown thereon as required by Osceola County requirements and regulations, the survey was prepared under the undersigned responsible direction and supervision and that the survey data complies with all requirements of Chapter 177, F.S.; that permanent control points will be placed as required by Ch. 177 F.S.; and that said land is located in Section 29, Township 26 South, Range 32 East, Osceola County, Florida.

CERTIFICATE OF REVIEW BY COUNTY SURVEYOR Upon a review: This Plat conforms to Chapter 177, F.S. (SIGNATURE) Robert D. Galbreath (PRINTED NAME) Robert D. Galbreath Dated 11/9/16 Registration No. 5031 Florida Professional Surveyor and Mapper in the State of Osceola County, Florida.

CERTIFICATE OF COUNTY CLERK I HEREBY CERTIFY, That I have examined the foregoing plat and find that it complies in form with all the requirements of the Osceola County Land Development Code, and was filed for record on 12/12/2016 at 01:24:50 PM File No. 2016183853 Amanda Ramirez, Clerk of the Circuit Court in and for Osceola County, Florida

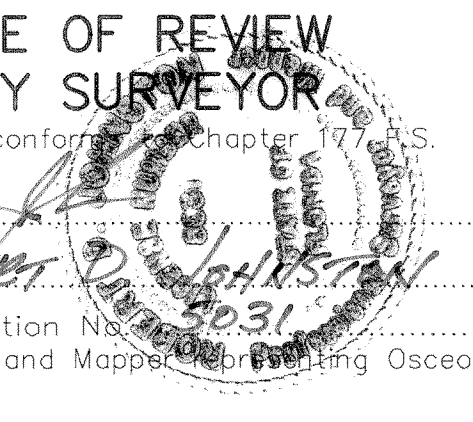
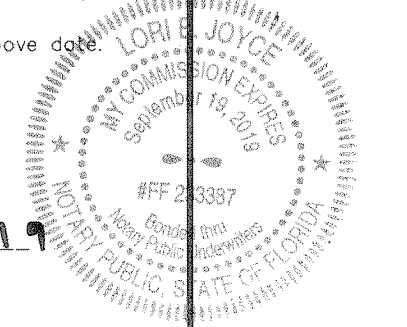

HARMONY NEIGHBORHOOD O-1

SECTION 29, TOWNSHIP 26 SOUTH, RANGE 32 EAST, OSCEOLA COUNTY, FLORIDA BEING A REPLAT OF TRACT M AND A PORTION OF TRACT L/U-2, HARMONY PHASE THREE, AS FILED AND RECORDED IN PLAT BOOK 20, PAGES 120 THRU 128 OF THE PUBLIC RECORDS OF OSCEOLA COUNTY, FLORIDA.

PLAT NOTES:

- 1. Bearings are based on the north line of Tract M, Harmony Phase Three, as filed and recorded in Plat Book 20, Pages 120 thru 128, Public Records of Osceola County, Florida, being S53°04'04"E (AS SHOWN).
2. THIS PLAT, AS RECORDED IN ITS GRAPHICAL FORM, IS THE OFFICIAL DEPICTION OF THE SUBDIVIDED LANDS DESCRIBED HEREIN AND WILL IN NO CIRCUMSTANCES BE SUPPLANTED IN AUTHORITY BY ANY OTHER GRAPHIC OR DIGITAL FORM OF THE PLAT.
3. THERE MAY BE ADDITIONAL RESTRICTIONS THAT ARE NOT RECORDED ON THIS PLAT THAT MAY BE FOUND IN THE PUBLIC RECORDS OF THIS COUNTY.
4. All lot lines are radial unless otherwise noted with (N.R. or Non-Radial).
5. This property is subject to the following items:
A. Drainage Easement between Birchwood Acres Limited Partnership and Harmony Community Development District recorded October 10, 2002, in Official Records Book 2125, Page 2078; First Amendment recorded October 10, 2002, in Official Records Book 2125, Page 2090; Second Amendment recorded November 25, 2003, in Official Records Book 2390, Page 1459; Third Amendment recorded November 1, 2004, in Official Records Book 2629, Page 288; Fourth Amendment recorded November 1, 2004, in Official Records Book 2629, Page 291; Fifth Amendment of Drainage Easement recorded June 24, 2005, in Official Records Book 2822, Page 1894; Sixth Amendment of Drainage Easement recorded October 27, 2006 in Official Records Book 3316, Page 2502; Seventh Amendment of Drainage Easement recorded February 23, 2009, in Book 3801, Page 2420, Public Records of Osceola County, Florida; and Eighth Amendment of Drainage Easement recorded January 21, 2016, in Book 4903, Page 749, Public Records of Osceola County, Florida.
B. Amended and Restated Easement and Development Agreement recorded January 17, 2006, in Official Records Book 3033, Page 967, Public Records of Osceola County, Florida.
C. Oil, Gas and Mineral Reservations, in favor of Consolidated Naval Stores Company set forth in that certain Deed recorded June 6, 1950, in Deed Book 131, Page 203; Conveyance of Interest in favor of Consolidated-Tomoka Land Co. set forth in that certain Warranty Deed recorded October 6, 1969, in Official Records Book 194, Page 132; Notice Pursuant to Section 704.05 and 712, Florida Statutes recorded August 19, 1975, in Official Records Book 314, Page 644 and Release of Surface Entry Rights with Respect to Oil, Gas and Mineral Interest recorded November 3, 1983, in Official Records Book 690, Page 452; Conveyance of Interest in favor of Indigo Group, Inc., a Florida corporation by Warranty Deed recorded December 13, 2004, in Official Records Book 2654, Page 1908 and Corrective Warranty Deed recorded May 17, 2006, in Official Records Book 3160, Page 732, Public Records of Osceola County, Florida.
D. Notice of Establishment of the Harmony Community Development District recorded March 24, 2000, in Official Records Book 1717, Page 1764; Amended Notice recorded May 8, 2000, in Official Records Book 1734, Page 1712 and Second Amended Notice recorded October 12, 2001, in Official Records Book 1943, Page 1779, Public Records of Osceola County, Florida.
E. Final Judgment recorded August 8, 2000, in Official Records Book 1766, Page 148 and Re-recorded August 17, 2000, in Official Records Book 1771, Page 893, Public Records of Osceola County, Florida.
F. Final Judgment recorded August 10, 2000, in Official Records Book 1767, Page 457 and Re-recorded August 29, 2000, in Official Records Book 1775, Page 952, Public Records of Osceola County, Florida.
G. Project Improvement Acquisition Agreement between Birchwood Acres Limited Partnership and Harmony Community Development District recorded April 6, 2001, in Official Records Book 1856, Page 656 and 1st Modification recorded October 12, 2001, in Official Records Book 1943, Page 1775, Public Records of Osceola County, Florida.
H. Interlocal Agreement Between Harmony Community Development District and Osceola County Pertaining to District Infrastructure Construction and Maintenance recorded August 2, 2001, in Official Records Book 1911, Page 2203 and Re-recorded in Official Records Book 1922, Page 649, Public Records of Osceola County, Florida.
I. Declaration of Consent to Jurisdiction of Community Development District and to Imposition of Special Assessments recorded October 9, 2001, in Official Records Book 1941, Page 2463 and Amended and Restated Declaration recorded October 23, 2002, in Official Records Book 2133, Page 915, Public Records of Osceola County, Florida.
J. Harmony Transition Interlocal Agreement recorded April 18, 2003, in Official Records Book 2233, Page 1582, Public Records of Osceola County, Florida.
K. DRI Transportation Proportionate Share Agreements recorded February 14, 2005, in Official Records Book 2703, Page 552 and recorded February 22, 2005, in Official Records Book 2708, Page 1412; First Amendment recorded February 5, 2007, in Official Records Book 3400, Page 765, Public Records of Osceola County, Florida.
L. Declaration of Consent to Jurisdiction of Community Development District and to Imposition of Special Assessments recorded April 1, 2005, in Official Records Book 2744, Page 1669, Public Records of Osceola County, Florida.
M. Board of Supervisors Harmony Community Development District Resolution 2006-1 recorded January 5, 2006, in Official Records Book 3021, Page 573, Public Records of Osceola County, Florida.
N. Service Agreement for Lighting Service (Phase 3 Roadway) recorded June 19, 2006, in Official Records Book 3190, Page 1474, Public Records of Osceola County, Florida.
O. South Florida Water Management District Notice of Environmental Resource or Surface Water Management Permit recorded October 24, 2012, in Book 4340, Page 1420, Public Records of Osceola County, Florida.
P. Agreement to Use Alternative Calculation Approach For Determining Capital Shortfall Amounts Between Birchwood Acres Limited Partnership, L.L.P. and Tohopekaliga Water Authority recorded September 6, 2013, in Book 4498, Page 1168, Public Records of Osceola County, Florida.
Q. Declaration of Consent to Jurisdiction of Community Development District and to Imposition of Special Assessments recorded April 30, 2015, in Official Records Book 4772, Page 1646, Public Records of Osceola County, Florida.
R. Assessment Acknowledgement and True Up Agreement recorded April 30, 2015, in Official Records Book 4772, Page 1654, Public Records of Osceola County, Florida.
S. Seventh Amended and Restated Development Order (March 14, 2016) recorded April 20, 2016, in Official Records Book 4946, Page 2444, Public Records of Osceola County, Florida.
T. Harmony Residential Properties Declaration of Covenants, Conditions and Restrictions recorded October 10, 2002, in Official Records Book 2125, Page 2093; First Amendment to the Declaration recorded May 1, 2003, in Official Records Book 2241, Page 2904; Amendment No. 1 to the By-Laws recorded September 10, 2003, in Official Records Book 2335, Page 962; Amendment No. 2 to the By-Laws recorded November 21, 2003, in Official Records Book 2388, Page 2263; First Supplemental Declaration recorded November 1, 2004, in Official Records Book 2629, Page 245; Second Supplemental Declaration recorded in Official Records Book 2629, Page 249; Third Amendment to the By-Laws recorded December 27, 2004, in Official Records Book 2661, Page 2378; Third Supplemental Declaration recorded April 22, 2005, in Official Records Book 2763, Page 865; Second Amendment to the Declaration recorded June 1, 2006, in Official Records Book 3174, Page 2640; Fourth Supplemental Declaration recorded October 27, 2006, in Official Records Book 3316, Page 2499; Third Amendment to the Declaration recorded March 8, 2010, in Official Records Book 3957, Page 1974; Fifth Supplemental Declaration recorded March 8, 2010, in Official Records Book 3957, Page 1988; Public Records of Osceola County, Florida; Sixth Supplemental Declaration recorded October 2, 2014, in Official Records Book 4674, Page 1904, Public Records of Osceola County, Florida; Seventh Supplemental Declaration recorded August 4, 2015, in Official Records Book 4820, Page 1319, Public Records of Osceola County, Florida; and Eighth Supplemental Declaration recorded August 4, 2015, in Official Records Book 4820, Page 1322, Public Records of Osceola County, Florida.
U. Service Agreement for Lighting Service (Phase 2 Roadway) recorded May 23, 2005, in Official Records Book 2785, Page 503 and Amendment No. One (1) recorded August 19, 2016, in Official Records Book 5011, Page 2564, Public Records of Osceola County, Florida.
V. Amendment No. One (1) to Service Agreement for Lighting Service recorded November 25, 2015, in Official Records Book 4877, Page 1268, Public Records of Osceola County, Florida.
W. Tohopekaliga Water Authority Water, Reuse and Wastewater System Developer's Service Agreement recorded March 15, 2016, in Official Records Book 4928, Page 1588, Public Records of Osceola County, Florida.
X. Service Agreement for Lighting Service Harmony Neighborhood O1 recorded August 5, 2016, in Official Records Book 5004, Page 2417, Public Records of Osceola County, Florida.

PLAT NOTES & EASEMENTS:

The Partnership and the HCDD further grant by means of this plat the following non-exclusive private or public easements shown hereon for the uses set forth below:

- A. Unless expressly and specifically provided otherwise, all easements described on this plat are private non-exclusive easements. With respect to all easements described in or reserved by this plat, (unless expressly and specifically provided otherwise), the right is hereby reserved to the Partnership and the HCDD (with respect to the HCDD, if specifically authorized by the plat, instrument of grant or assignment) to: (i) assign the same to others, (ii) grant a part or all of said easements to others, and (iii) grant and empower the assignees or grantees thereof to grant such additional easements over any part or all of such easements as the Partnership or the HCDD may deem necessary or appropriate; provided, none of the grants or additional easements shall impair or detract from the use of the easements depicted on this plat for the uses herein expressed and provided that said grant or additional easements shall not be deemed a public dedication of said easements.
B. The Partnership hereby reserves to itself (and to its grantees and assignees, if specifically authorized by the plat, instrument of grant or assignment) the exclusive right and privilege to determine the location of any improvements, equipment, driveways, curb cuts, paved areas or facilities to be placed within, on or beneath the surface of all easements granted by, described in or reserved by this plat and the Partnership retains (for itself and its grantees or assigns) the right of access and use over and across all said easements for improvement, construction and maintenance purposes and to grant or assign such rights to others.
C. Unless specifically provided otherwise on this plat, successors in interest to the Partnership shall not succeed to rights reserved by the Partnership on this plat unless a recorded instrument makes reference to the right or rights reserved by the Partnership and assigns such right or rights to said successors in interest.
D. All platted utility easements shall provide that such easements shall also be easements for the construction, installation, maintenance, and operation of cable television services; provided, however, no such construction, installation, maintenance, and operation of cable television services shall interfere with the facilities and services of an electric, telephone, gas, or other public utility.
E. This Plat does not contain a Tract O-200 or Tract O-500.

- 1. [Easement #1] Partnership and the HCDD (as grantor) hereby grant and convey and reserve, by this plat to the Partnership and the HCDD (as grantee) a perpetual non-exclusive easement on, over and under all publicly dedicated portions of the streets in this plat for the purpose of: drainage; utilities; water; sanitary sewer; irrigation; parking; the right, but not the obligation, to perform road maintenance and maintenance of crosswalks; the right, but not the obligation, to maintain brick pavers from time to time; access on, over, to and from any and all driveways and curb cuts in or abutting said streets; and the right, but not the obligation to, perform landscape maintenance in unpaved areas.
2. [Easement #2] Partnership and the HCDD (as grantor) hereby grant and convey to the Partnership (as grantee) and the Partnership reserves for itself, its successors and assigns, a private perpetual non-exclusive easement on, over and under Tract O-100, Tract O-300, Tract O-400 and Tract O-600 for: road drainage; utilities; cable television; irrigation; parking; the right, but not the obligation, to perform road maintenance and maintenance of crosswalks; the right, but not the obligation, to pave and construct driveways and curb cuts subject to and in accordance with the rights of the Partnership as set forth in Plat Note B; access to the contiguous publicly dedicated portion of the rights-of-way dedicated by this plat (and the Plat of HARMONY PHASE THREE, recorded in Plat Book 20, Pages 128-128, of the Public Records of Osceola County, Florida) via the driveways and curb cuts now or in the future constructed thereon in accordance with and subject to the rights of the Partnership as set forth in Plat Note B; encroachments of structures, structural overhangs, foundations, footers, and maintenance of those structures; the right, but not the obligation to, perform landscaping maintenance; and the right, but not the obligation to, install and maintain signage, lighting, utilities, mailboxes, decorative improvements, including, but not limited to, fencing and entry features.

- 3. [Easement #3] Partnership and the HCDD (as grantor) each (i) hereby reserves for itself and grant to each other and their successors and assigns a perpetual non-exclusive access easement over the 20' Wide Stabilized and Graded Emergency Access Easement for their respective purposes, and (ii) hereby dedicate on this plat to Osceola County (as grantee) a perpetual non-exclusive emergency access easement over the 20' Wide Stabilized and Graded Emergency Access Easement solely for emergency (police, fire, medical, natural disaster) access purposes. The HCDD shall be responsible for maintaining the 20' Wide Stabilized and Graded Emergency Access Easement.

- 4. [Easement #4] Partnership and the HCDD (as grantor) each hereby reserves for itself and grant to each other and their successors and assigns a temporary non-exclusive access and construction easement over the publicly dedicated portions of the rights-of-way dedicated by this plat for the purpose of construction of such rights-of-way. Such temporary non-exclusive access and construction easement shall automatically expire upon issuance by Osceola County, Florida of a certificate of completion for such rights-of-way.

- 5. [Easement #5] Partnership and the HCDD (as grantor) hereby grant and convey to Osceola County, Florida a perpetual non-exclusive easement over the "0.0' Utility Easements" and "10' U.E." for purposes of: the installation, maintenance, repair and replacement of utility facilities.

- 6. [Easement #6] Partnership (as grantor) hereby reserves for itself and grants and conveys to the HCDD a perpetual non-exclusive easement over the "20' Drainage Easement" for purposes of: drainage and installation, maintenance, repair and replacement of drainage facilities.

- 7. [Easement #7] Partnership and the HCDD (as grantor) hereby grant and convey to the Partnership (as grantee) and the Partnership reserves for itself, its successors and assigns, a private perpetual non-exclusive easement on and over Tract O-400 for purposes of access, ingress and egress to and from conservation areas adjacent to Tract O-400, including, but not limited to, the xeric oak preserve, which shall include, but not be limited to, the right to install, construct and maintain access facilities on Tract O-400 for such purposes.

- 8. All landscaping elements within this development including trees in Public Right of Ways as required by the Osceola Land Development Code shall be maintained by the HCDD.

- 9. All street lights are to be owned and maintained by the HCDD and/or the Utility Provider, which ever apply.



LEGEND:
O DENOTES FOUND 1/2" IRON ROD (LB 7048), REPLACED WITH PRM 5/8" IRON ROD W/CAP (LB 966)
D DENOTES FOUND IRON ROD (AS NOTED)
● DENOTES SET 5/8" IRON ROD W/CAP (LB 966)
▲ DENOTES NAIL AND DISK FOUND (AS NOTED)
▲ DENOTES SET PCP NAIL AND DISK (LB 966)
CHD = CHORD DISTANCE FC = PAGE
R = RADIUS P.O.B = POINT OF BEGINNING
Δ = CENTRAL ANGLE P.O.C = POINT OF COMMENCEMENT
L = ARC LENGTH L.B. = LICENSED BUSINESS
CB = CHORD BEARING I.D. = IDENTIFICATION
C.R. = COUNTY ROAD C/L = CENTERLINE
(RAD.) = RADIAL LOT LINE
PRM = PERMANENT REFERENCE MONUMENT
PCP = PERMANENT CONTROL POINT
P.C. = POINT OF CURVE
P.T. = POINT OF TANGENT
P.R.C. = POINT OF REVERSE CURVE
P.C.C. = POINT OF COMPOUND CURVE
FD. = FOUND
P.S.M. = PROFESSIONAL SURVEYOR & MAPPER
HCDD = HARMONY COMMUNITY DEVELOPMENT DISTRICT
L/U. = LANDSCAPE & UTILITY
TWP. = TOWNSHIP
RSE = RANGE
(N.R.) = NON-RADIAL LOT LINE
D.E. = DRAINAGE EASEMENT
U.E. = UTILITY EASEMENT
D.U.E. = DRAINAGE/UTILITY EASEMENT
PB. = PLAT BOOK

# HARMONY NEIGHBORHOOD O-1

SECTION 29, TOWNSHIP 26 SOUTH, RANGE 32 EAST,  
OSCEOLA COUNTY, FLORIDA  
BEING A REPLAT OF TRACT M AND A PORTION OF TRACT  
L/U-2, HARMONY PHASE THREE, AS FILED AND RECORDED  
IN PLAT BOOK 20, PAGES 120 THRU 128 OF THE PUBLIC  
RECORDS OF OSCEOLA COUNTY, FLORIDA.

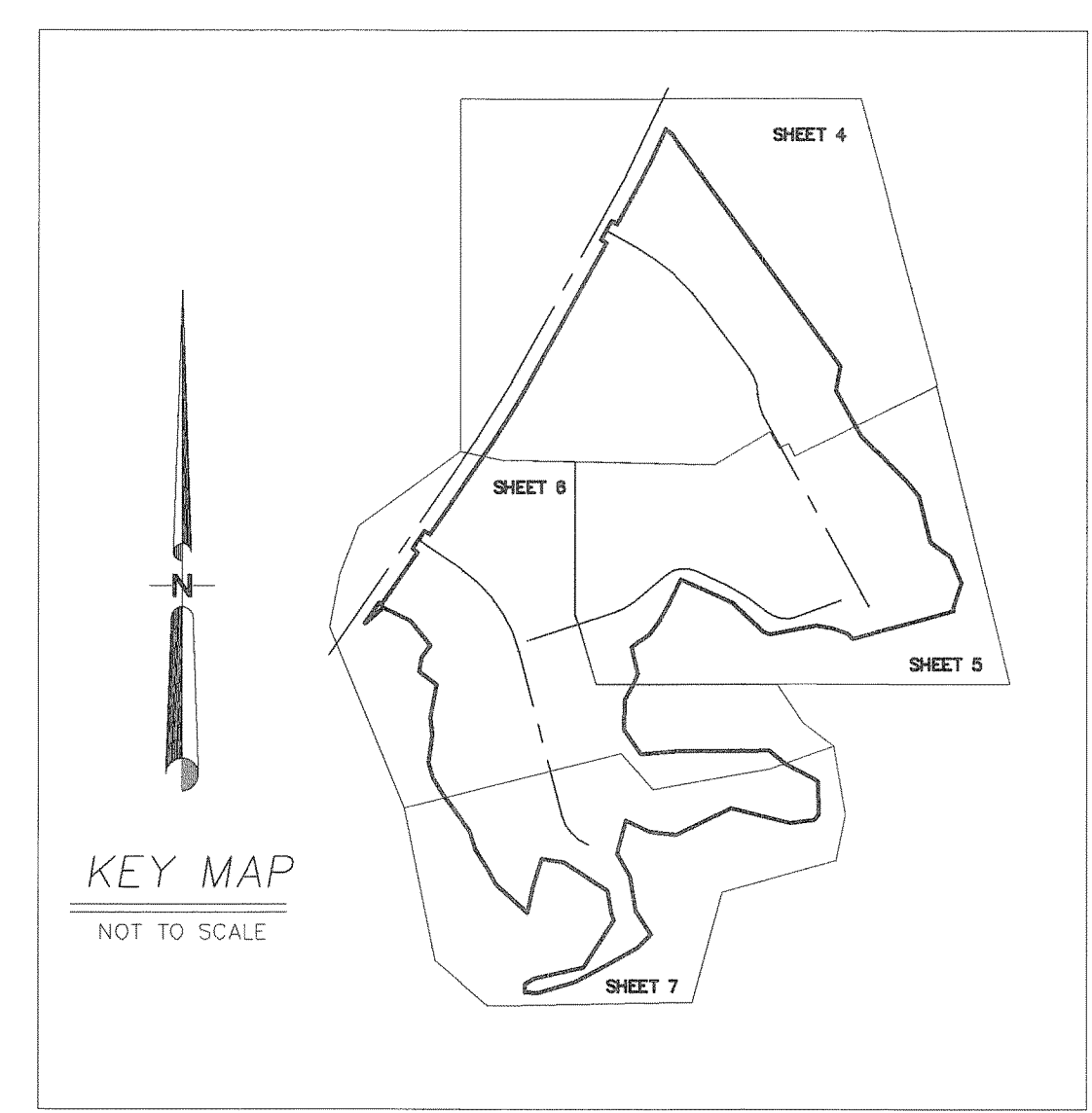
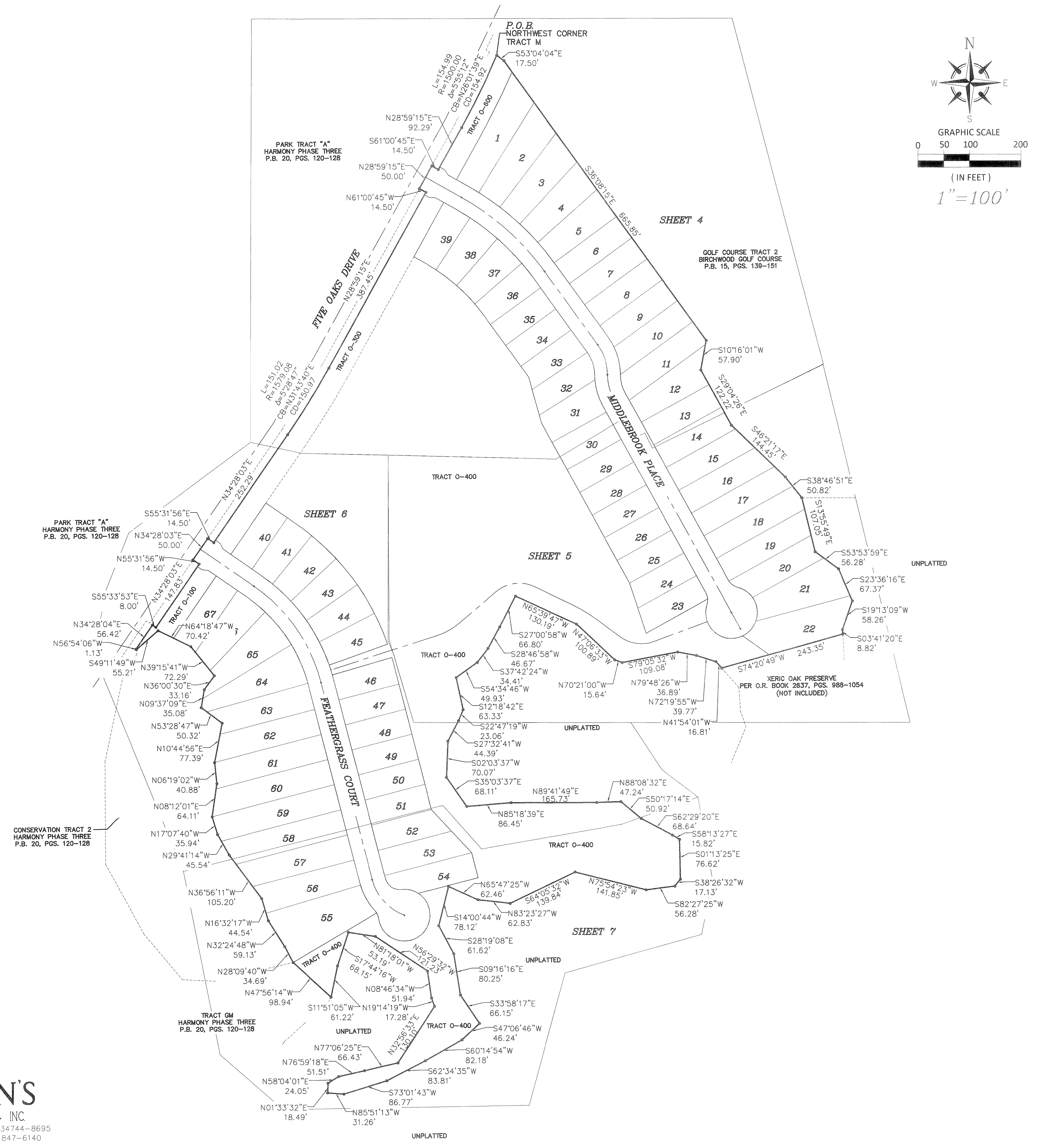
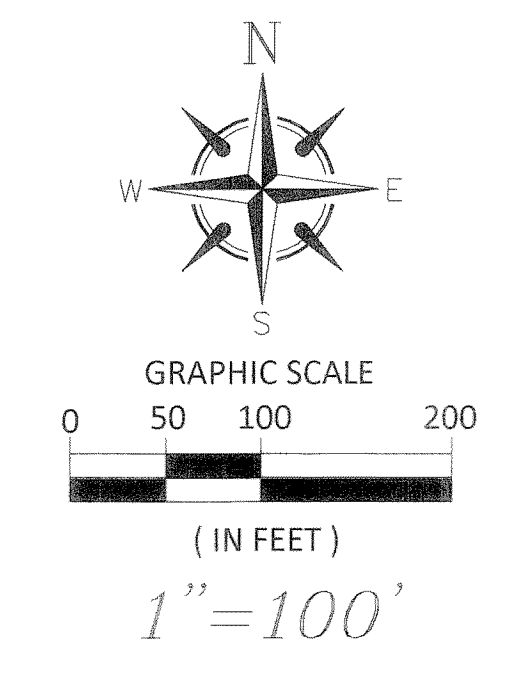

NOTE: SEE SHEETS 1 AND 2 FOR LEGAL DESCRIPTION, NOTES & EASEMENTS

LEGEND:

○ DENOTES FOUND 1/2" IRON ROD (LB 7048), REPLACED WITH PRM 5/8" IRON ROD W/CAP (LB 966)	PRM = PERMANENT REFERENCE POINT	L/U. = LANDSCAPE & UTILITY
□ DENOTES FOUND IRON ROD (AS NOTED)	PCR = PERMANENT CONTROL POINT	TWP. = TOWNSHIP
● DENOTES SET 5/8" IRON ROD W/CAP (LB 966)	P.C. = POINT OF CURVE	RGE = RANGE
△ DENOTES NAIL AND DISK FOUND (AS NOTED)	P.R.C. = POINT OF REVERSE CURVE	(N.R.) = NON-RADIAL LOT LINE
▲ DENOTES SET PCR NAIL AND DISK (LB 966)	P.T. = POINT OF TANGENT	D.E. = DRAINAGE EASEMENT
CHD. = CHORD DISTANCE	P.O.B. = POINT OF BEGINNING	U.E. = UTILITY EASEMENT
R = RADIUS	P.O.C. = POINT OF COMMENCEMENT	D.U.E. = DRAINAGE/UTILITY EASEMENT
∠ = CENTRAL ANGLE	L.B. = LICENSED BUSINESS	P.B. = PLAT BOOK
L = ARC LENGTH	P.C.C. = POINT OF COMPOUND CURVE	
C.B. = CHORD BEARING	FD. = FOUND	
C.R. = COUNTY ROAD	P.S.M. = PROFESSIONAL SURVEYOR & MAPPER	
(RAD.) = RADIAL LOT LINE	HCDD = HARMONY COMMUNITY DEVELOPMENT DISTRICT	
	C/L = CENTERLINE	

**JOHNSTON'S**  
SURVEYING INC  
900 Shady Lane, Kissimmee, Florida 34744-8695  
Tel. (407) 847-2179 Fax (407) 847-6140

# HARMONY NEIGHBORHOOD O-1

SECTION 29, TOWNSHIP 26 SOUTH, RANGE 32 EAST,  
OSCEOLA COUNTY, FLORIDA  
BEING A REPLAT OF TRACT M AND A PORTION OF TRACT  
L/U-2, HARMONY PHASE THREE, AS FILED AND RECORDED  
IN PLAT BOOK 20, PAGES 120 THRU 128 OF THE PUBLIC  
RECORDS OF OSCEOLA COUNTY, FLORIDA.

PARK TRACT "A"  
HARMONY PHASE THREE  
P.B. 20, PGS. 120-128

REMAINDER OF TRACT L/U-2  
HARMONY PHASE THREE  
P.B. 20, PGS. 120-128  
(NOT INCLUDED)

REMAINDER OF TRACT L/U-2  
HARMONY PHASE THREE  
P.B. 20, PGS. 120-128  
(NOT INCLUDED)

P.O.B.  
NORTHWEST CORNER  
TRACT M  
S53°04'04"E  
17.50'

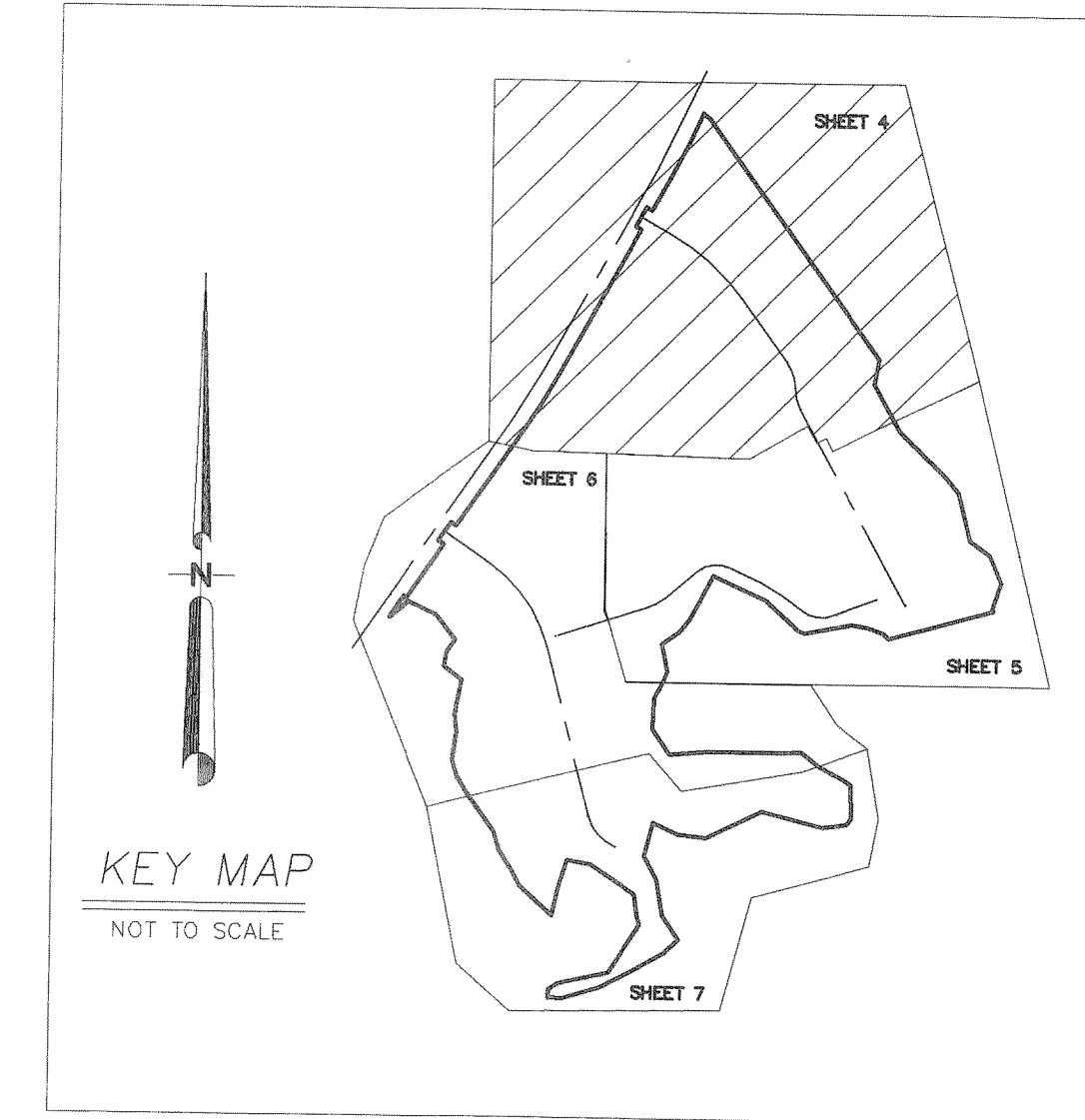
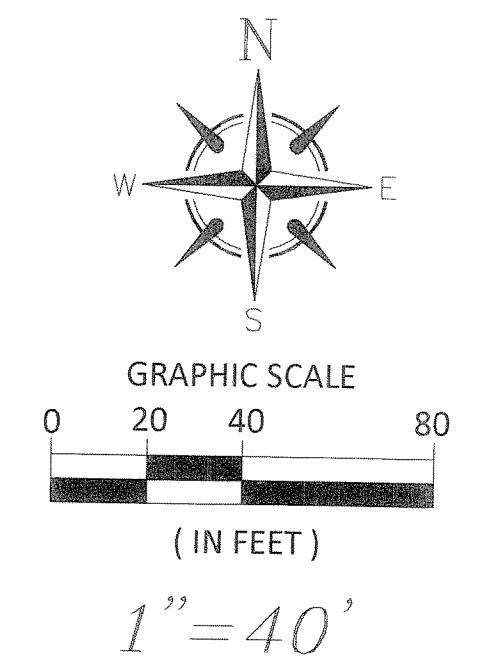

CURVE TABLE					
CURVE #	LENGTH	RADIUS	DELTA	CHORD LENGTH	CHD. BEARING
C1	25.25	525.00	002°45'22"	25.25	N59°38'04"W
C2	141.27	1540.00	005°15'22"	141.22	N26°21'34"E
C3	50.01	525.00	005°27'28"	49.99	N55°31'39"W
C4	50.03	525.00	005°27'37"	50.01	N50°04'07"W
C5	50.03	525.00	005°27'37"	50.01	N44°36'30"W
C6	50.02	525.00	005°27'30"	50.00	N39°08'56"W
C7	2.59	525.00	000°16'56"	2.59	N36°16'42"W
C8	22.84	125.00	010°28'02"	22.80	N30°54'13"W
C9	49.87	125.00	022°51'37"	49.54	N14°14'24"W
C10	4.89	125.00	002°14'28"	4.89	N01°41'22"W
C11	62.13	100.00	035°35'52"	61.14	N18°20'18"W
C12	37.42	75.00	028°33'01"	37.03	S14°46'56"E
C13	49.80	100.00	028°32'04"	49.29	S14°48'24"E
C14	1.74	27.50	003°37'16"	1.74	S30°53'04"E
C15	36.05	50.00	041°16'19"	35.27	N55°46'44"W
C16	47.52	50.00	054°27'35"	45.76	N07°53'48"W
C17	39.11	50.00	044°49'01"	38.12	N41°44'30"E
C21	52.63	125.00	024°07'25"	52.24	S17°00'44"E
C22	9.62	125.00	004°24'39"	9.62	S02°44'41"E
C23	46.60	75.00	035°35'52"	45.85	N18°20'18"W
C24	38.61	475.00	004°39'27"	38.60	N38°27'58"W
C25	66.90	475.00	008°04'11"	66.85	N44°49'48"W
C26	66.90	475.00	008°04'11"	66.85	N52°53'58"W
C27	33.81	475.00	004°04'41"	33.80	N58°58'24"W
C28	25.27	355.00	004°04'41"	25.26	N58°58'24"W
C29	50.00	355.00	008°04'11"	49.96	N52°53'58"W
C30	50.00	355.00	008°04'11"	49.96	N44°49'48"W
C31	28.86	355.00	004°39'27"	28.85	N38°27'58"W
C32	37.09	470.00	004°31'19"	37.08	N53°16'17"W
C33	64.74	470.00	007°53'31"	64.69	N47°03'52"W
C34	64.74	470.00	007°53'31"	64.69	N39°10'21"W
C35	64.74	470.00	007°53'31"	64.69	N31°16'49"W
C36	64.74	470.00	007°53'31"	64.69	N23°23'18"W
C37	12.06	470.00	001°28'11"	12.06	N19°25'59"W
C38	34.84	50.00	039°55'44"	34.14	N77°11'31"W
C39	36.65	27.50	076°20'59"	33.99	S58°58'53"E
C40	8.00	75.00	006°06'30"	7.99	S17°45'09"E
C41	95.94	100.00	054°58'07"	92.30	S42°10'57"E
C42	8.98	350.00	001°28'11"	8.98	N15°25'59"W
C43	48.21	350.00	007°53'31"	48.17	N23°23'18"W
C44	48.21	350.00	007°53'31"	48.17	N31°16'49"W
C45	48.21	350.00	007°53'31"	48.17	N39°10'21"W
C46	48.21	350.00	007°53'31"	48.17	N47°03'52"W
C47	27.62	350.00	004°31'19"	27.62	N53°16'17"W
C48	46.46	300.00	008°52'23"	46.41	N51°05'45"W
C49	81.08	300.00	015°29'07"	80.83	N38°55'00"W
C50	81.08	300.00	015°29'07"	80.83	N23°25'53"W
C51	5.19	300.00	000°59'25"	5.19	N15°11'37"W
C52	4.20	125.00	001°55'30"	4.20	S15°39'39"E
C53	57.49	125.00	026°21'10"	56.99	S29°47'59"E
C54	5.41	27.50	011°15'43"	5.40	N37°20'42"W
C55	11.60	27.50	024°09'34"	11.51	N19°38'04"W
C56	200.43	50.00	229°40'22"	90.75	N57°36'32"E
C57	227.93	525.00	024°52'30"	226.14	N48°34'29"W
C58	77.66	125.00	035°35'52"	76.42	N18°20'18"W
C59	117.05	50.00	134°08'01"	92.10	S48°46'59"E
C60	239.73	50.00	274°42'55"	67.74	N60°55'34"E
C61	10.45	27.50	021°46'57"	10.39	N07°23'33"E
C62	12.28	27.50	025°34'30"	12.17	N16°17'11"W
C63	22.73	27.50	047°21'28"	22.09	N05°23'42"E
C64	62.25	125.00	028°32'04"	61.61	S14°48'24"E
C65	206.22	475.00	024°52'30"	204.61	N48°34'29"W
C66	154.12	355.00	024°52'30"	152.92	N48°34'29"W
C67	296.05	470.00	036°05'24"	291.18	N37°29'15"W
C68	249.44	350.00	040°50'02"	244.20	N35°06'55"W
C70	235.27	50.00	269°36'05"	70.96	N37°38'40"E
C71	17.00	27.50	035°25'17"	16.73	N25°15'56"W
C72	61.69	125.00	028°16'40"	61.07	S28°50'14"E
C73	213.61	300.00	040°50'02"	209.31	N35°06'55"W
C74	217.08	500.00	024°52'30"	215.38	N48°34'29"W
C75	69.15	70.00	056°35'59"	66.37	S82°08'15"E
C76	80.39	70.00	065°47'47"	76.04	S82°33'58"W
C77	49.15	125.00	022°31'36"	48.83	N60°55'33"E
C78	231.62	325.00	040°50'02"	226.75	N35°06'55"W
C79	10.00	350.00	001°38'14"	10.00	N18°37'26"W
C80	10.00	350.00	001°38'14"	10.00	N16°59'12"W
C81	33.79	50.00	038°43'16"	33.15	S01°04'36"E
C82	4.75	9.00	030°13'01"	4.69	N70°38'27"W
C83	2.64	5.00	030°13'01"	2.61	N70°38'27"W
C84	4.75	9.00	030°13'01"	4.69	N40°25'26"W
C85	2.64	5.00	030°13'01"	2.61	N40°25'26"W
C86	4.62	9.00	029°23'15"	4.57	N75°42'22"W
C87	2.56	5.00	029°23'15"	2.54	N75°42'22"W
C88	4.67	9.00	029°45'26"	4.62	N46°08'02"W
C89	2.60	5.00	029°45'26"	2.57	N46°08'01"W
C91	0.25	75.00	000°11'28"	0.25	N36°02'30"W
C92	20.99	27.50	043°44'12"	20.49	S54°33'48"E

LINE TABLE		
LINE #	DIRECTION	LENGTH
L1	N55°31'56"W	8.61'
L2	N85°44'57"W	7.79'
L3	N55°31'56"W	17.62'
L4	N55°31'56"W	8.61'
L5	N25°18'56"W	7.79'
L6	N55°31'56"W	17.62'
L7	N61°00'45"W	8.12'
L8	S89°36'00"W	7.79'
L9	N61°00'45"W	18.22'
L10	N61°00'45"W	9.00'
L11	N31°15'18"W	7.82'
L12	N61°00'45"W	17.26'

C/L FIVE OAKS DRIVE  
ALSO SEE P.P. 2

C/L MIDDLEBROOK PLACE  
ALSO SEE P.P. 2

GOLF COURSE TRACT 2  
BIRCHWOOD GOLF COURSE  
PLAT BOOK 15 PAGES 139-151

**JOHNSTON'S**  
SURVEYING INC.  
900 Shady Lane, Kissimmee, Florida 34744-8695  
Tel. (407) 847-2179 Fax (407) 847-6140

SEE SHEET 6 OF 7

SEE SHEET 5 OF 7

NOTE: SEE SHEETS 1-3 FOR LEGAL DESCRIPTION, NOTES, EASEMENTS & LEGEND

# HARMONY NEIGHBORHOOD O-1

SECTION 29, TOWNSHIP 26 SOUTH, RANGE 32 EAST,  
OSCEOLA COUNTY, FLORIDA  
BEING A REPLAT OF TRACT M AND A PORTION OF TRACT  
L/U-2, HARMONY PHASE THREE, AS FILED AND RECORDED  
IN PLAT BOOK 20, PAGES 120 THRU 128 OF THE PUBLIC  
RECORDS OF OSCEOLA COUNTY, FLORIDA.

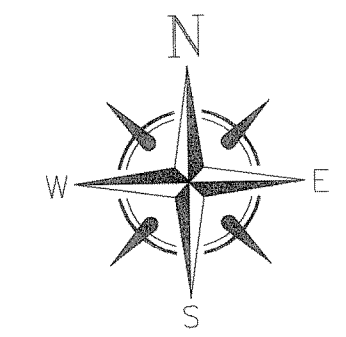

GRAPHIC SCALE  
0 20 40 80  
(IN FEET)

1" = 40'

SEE SHEET 4 OF 7

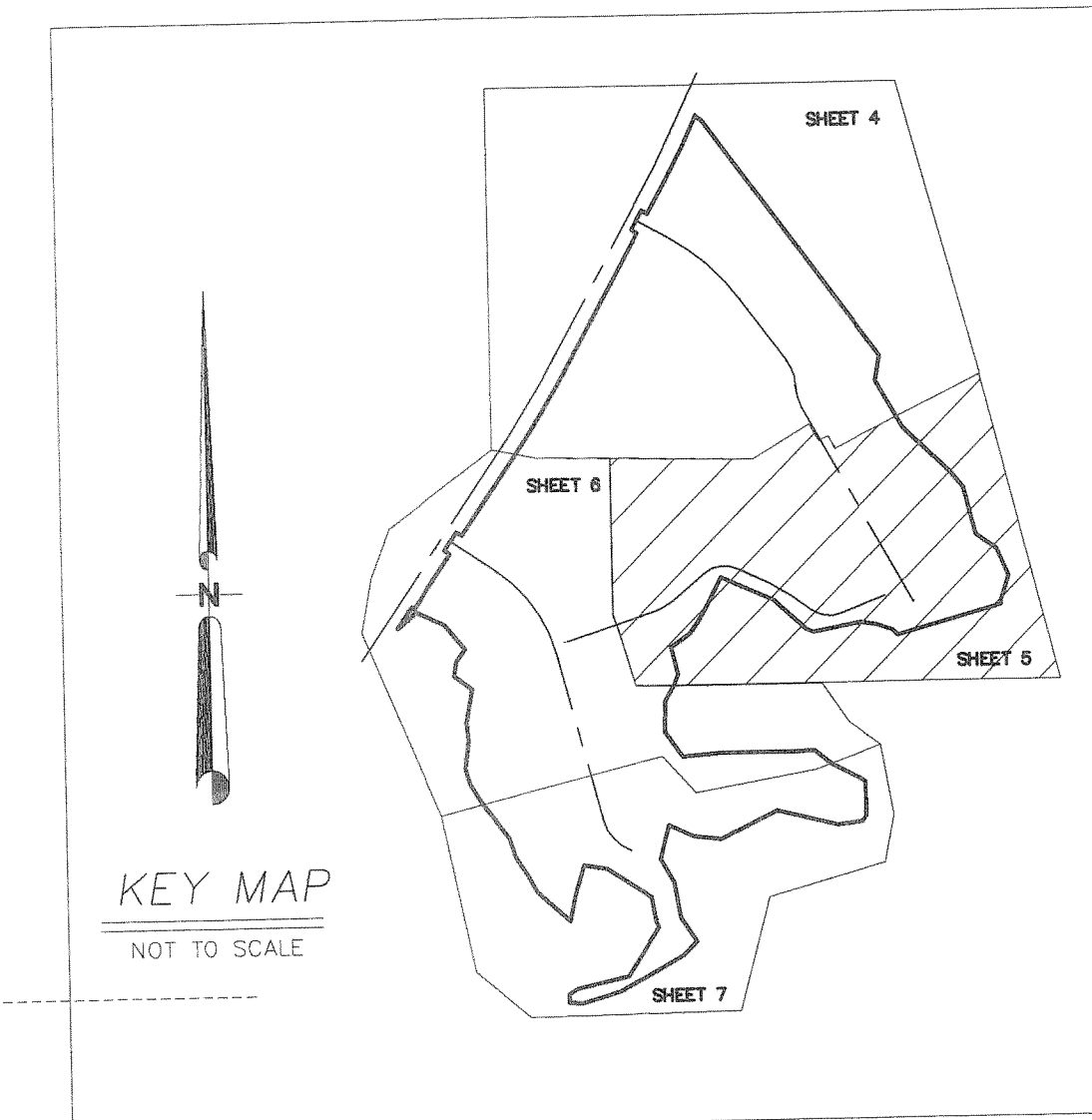

CURVE TABLE					
CURVE #	LENGTH	RADIUS	DELTA	CHORD LENGTH	CHD. BEARING
C1	25.25	525.00	002°45'22"	25.25	N59°38'04"W
C2	141.27	1540.00	005°15'22"	141.22	N26°21'34"E
C3	50.01	525.00	005°27'28"	49.99	N55°31'39"W
C4	50.03	525.00	005°27'37"	50.01	N50°04'07"W
C5	50.03	525.00	005°27'37"	50.01	N44°36'30"W
C6	50.02	525.00	005°27'30"	50.00	N39°08'56"W
C7	2.59	525.00	000°16'56"	2.59	N36°16'42"W
C8	22.84	125.00	010°28'02"	22.80	N30°54'13"W
C9	49.87	125.00	022°51'37"	49.54	N14°14'24"W
C10	4.89	125.00	002°14'28"	4.89	N01°41'22"W
C11	62.13	100.00	035°35'52"	61.14	N18°20'18"W
C12	37.42	75.00	028°35'01"	37.03	S14°46'56"E
C13	49.80	100.00	028°32'04"	49.29	S14°48'24"E
C14	1.74	27.50	003°37'16"	1.74	S30°53'04"E
C15	36.05	50.00	041°18'19"	35.27	N55°46'44"W
C16	47.52	50.00	054°27'35"	45.76	N07°53'48"W
C17	39.11	50.00	044°49'01"	38.12	N41°44'30"E
C21	52.63	125.00	024°07'25"	52.24	S17°00'44"E
C22	9.62	125.00	004°24'39"	9.62	S02°44'41"E
C23	46.60	75.00	035°35'52"	45.85	N18°20'18"W
C24	38.61	475.00	004°39'27"	38.60	N38°27'58"W
C25	66.90	475.00	008°04'11"	66.85	N44°49'46"W
C26	66.90	475.00	008°04'11"	66.85	N52°53'58"W
C27	33.81	475.00	004°04'41"	33.80	N58°58'24"W
C28	25.27	355.00	004°04'41"	25.26	N58°58'24"W
C29	50.00	355.00	008°04'11"	49.96	N52°53'58"W
C30	50.00	355.00	008°04'11"	49.96	N44°49'46"W
C31	28.86	355.00	004°39'27"	28.85	N38°27'58"W
C32	37.09	470.00	004°31'19"	37.08	N53°16'17"W
C33	64.74	470.00	007°53'31"	64.69	N47°03'52"W
C34	64.74	470.00	007°53'31"	64.69	N39°10'21"W
C35	64.74	470.00	007°53'31"	64.69	N31°16'49"W
C36	64.74	470.00	007°53'31"	64.69	N23°23'18"W
C37	12.06	470.00	001°28'11"	12.06	N19°25'59"W
C38	34.84	50.00	039°55'44"	34.14	N77°11'31"W
C39	36.65	27.50	076°20'59"	33.99	S58°58'53"E
C40	8.00	75.00	006°06'30"	7.99	S17°45'09"E
C41	95.94	100.00	084°58'07"	92.30	S42°10'57"E
C42	8.98	350.00	001°28'11"	8.98	N15°25'59"W
C43	48.21	350.00	007°53'31"	48.17	N23°23'18"W
C44	48.21	350.00	007°53'31"	48.17	N31°16'49"W
C45	48.21	350.00	007°53'31"	48.17	N39°10'21"W
C46	48.21	350.00	007°53'31"	48.17	N47°03'52"W
C47	27.62	350.00	004°31'19"	27.62	N53°16'17"W
C48	46.46	300.00	008°52'23"	46.41	N51°05'45"W
C49	81.08	300.00	015°29'07"	80.83	N38°55'00"W
C50	81.08	300.00	015°29'07"	80.83	N23°23'18"W
C51	5.19	300.00	000°59'25"	5.19	N15°11'37"W
C52	4.20	125.00	001°55'30"	4.20	S15°39'39"E
C53	57.49	125.00	026°21'10"	56.99	S29°47'59"E
C54	5.41	27.50	011°15'43"	5.40	N37°20'42"W
C55	11.60	27.50	024°09'34"	11.51	N19°38'04"W
C56	200.43	50.00	229°40'22"	90.75	N57°36'32"E
C57	227.93	525.00	024°52'30"	226.14	N48°34'29"W
C58	77.66	125.00	035°35'52"	76.42	N18°20'18"W
C59	117.05	50.00	134°08'01"	92.10	S48°46'59"E
C60	239.73	50.00	274°42'55"	67.74	N60°55'34"E
C61	10.45	27.50	021°46'57"	10.39	N07°23'33"E
C62	12.28	27.50	025°34'30"	12.17	N16°17'11"W
C63	22.73	27.50	047°21'28"	22.09	N05°23'42"W
C64	62.25	125.00	028°32'04"	61.61	S14°48'24"E
C65	206.22	475.00	024°52'30"	204.61	N48°34'29"W
C66	154.12	355.00	024°52'30"	152.92	N48°34'29"W
C67	296.05	470.00	036°03'24"	291.18	N37°29'15"W
C68	249.44	350.00	040°50'02"	244.20	N35°06'55"W
C70	235.27	50.00	269°36'05"	70.96	N37°38'40"E
C71	17.00	27.50	035°25'17"	16.73	N25°15'56"W
C72	61.69	125.00	028°16'40"	61.07	S28°50'14"E
C73	213.81	300.00	040°50'02"	209.31	N35°06'55"W
C74	217.08	500.00	024°52'30"	215.38	N48°34'29"W
C75	69.15	70.00	056°35'59"	66.37	S82°08'15"E
C76	80.39	70.00	065°47'47"	76.04	S82°33'58"W
C77	49.15	125.00	022°31'36"	48.83	N60°55'53"E
C78	231.62	325.00	040°50'02"	226.75	N35°06'55"W
C79	10.00	350.00	001°38'14"	10.00	N18°37'26"W
C80	10.00	350.00	001°38'14"	10.00	N16°59'12"W
C81	33.79	50.00	038°43'16"	33.15	S01°04'36"E
C82	4.75	9.00	030°13'01"	4.69	N70°38'27"W
C83	2.64	5.00	030°13'01"	2.61	N70°38'27"W
C84	4.75	9.00	030°13'01"	4.69	N40°25'26"W
C85	2.64	5.00	030°13'01"	2.61	N40°25'26"W
C86	4.62	9.00	029°23'15"	4.57	N75°42'22"W
C87	2.56	5.00	029°23'15"	2.54	N75°42'22"W
C88	4.67	9.00	029°45'26"	4.62	N46°08'02"W
C89	2.60	5.00	029°45'27"	2.57	N46°08'01"W
C91	0.25	75.00	000°11'28"	0.25	N36°02'30"W
C92	20.99	27.50	043°44'12"	20.49	S54°33'48"E

LINE TABLE		
LINE #	DIRECTION	LENGTH
L1	N55°31'56"W	8.61'
L2	N85°44'57"W	7.79'
L3	N55°31'56"W	17.62'
L4	N55°31'56"W	8.61'
L5	N25°18'56"W	7.79'
L6	N55°31'56"W	17.62'
L7	N61°00'45"W	8.12'
L8	S89°36'00"W	7.79'
L9	N61°00'45"W	18.22'
L10	N61°00'45"W	9.00'
L11	N31°15'18"W	7.82'
L12	N61°00'45"W	17.26'

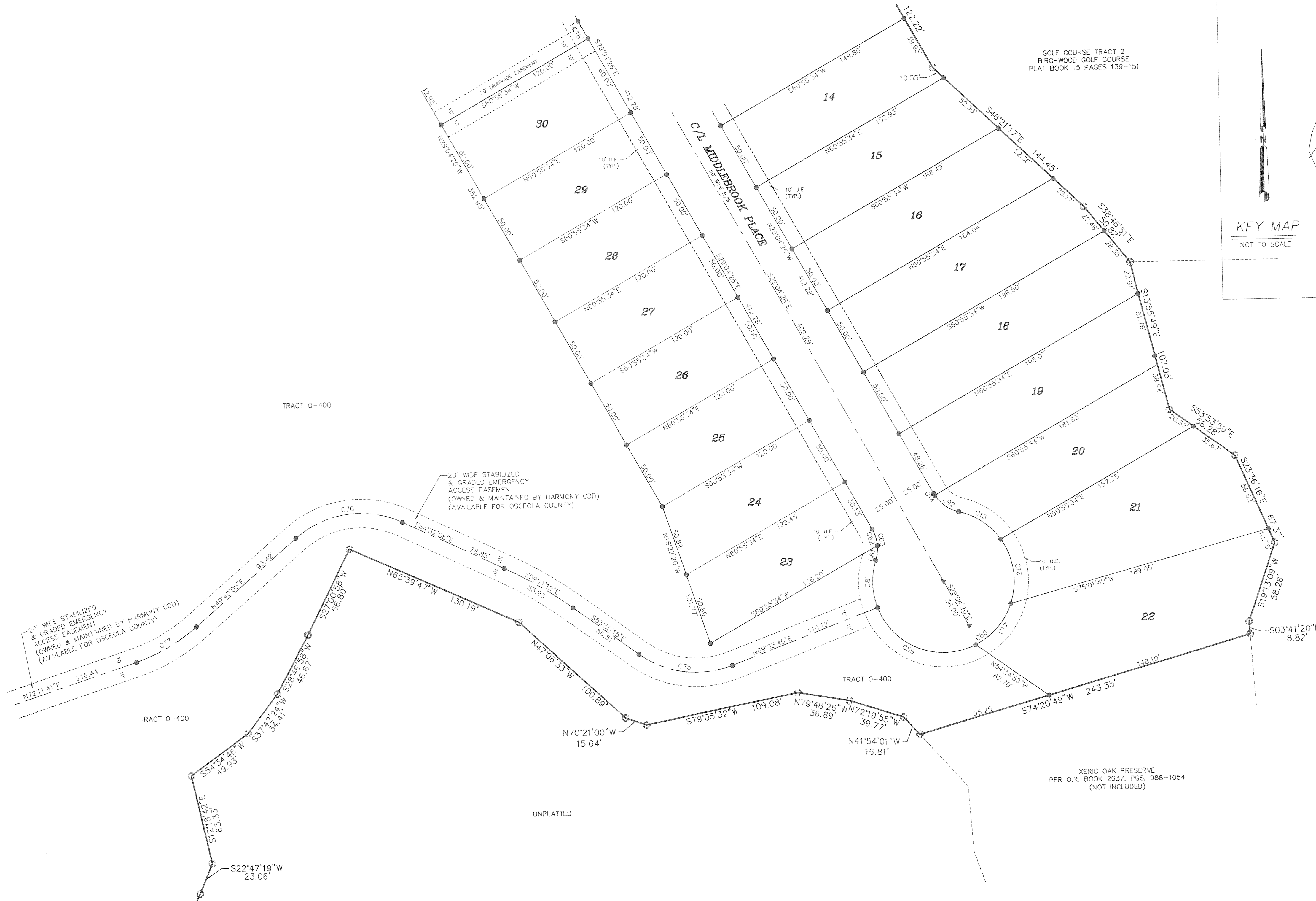

SEE SHEET 6 OF 7

SEE SHEET 6 OF 7

**JOHNSTON'S**  
SURVEYING INC.  
900 Shady Lane, Kissimmee, Florida 34744-8695  
Tel. (407) 847-2179 Fax (407) 847-6140

NOTE: SEE SHEETS 1-3 FOR LEGAL DESCRIPTION, NOTES, EASEMENTS & LEGEND

# HARMONY NEIGHBORHOOD O-1

SECTION 29, TOWNSHIP 26 SOUTH, RANGE 32 EAST,  
OSCEOLA COUNTY, FLORIDA  
BEING A REPLAT OF TRACT M AND A PORTION OF TRACT  
L/U-2, HARMONY PHASE THREE, AS FILED AND RECORDED  
IN PLAT BOOK 20, PAGES 120 THRU 128 OF THE PUBLIC  
RECORDS OF OSCEOLA COUNTY, FLORIDA.

SEE SHEET 4 OF 7

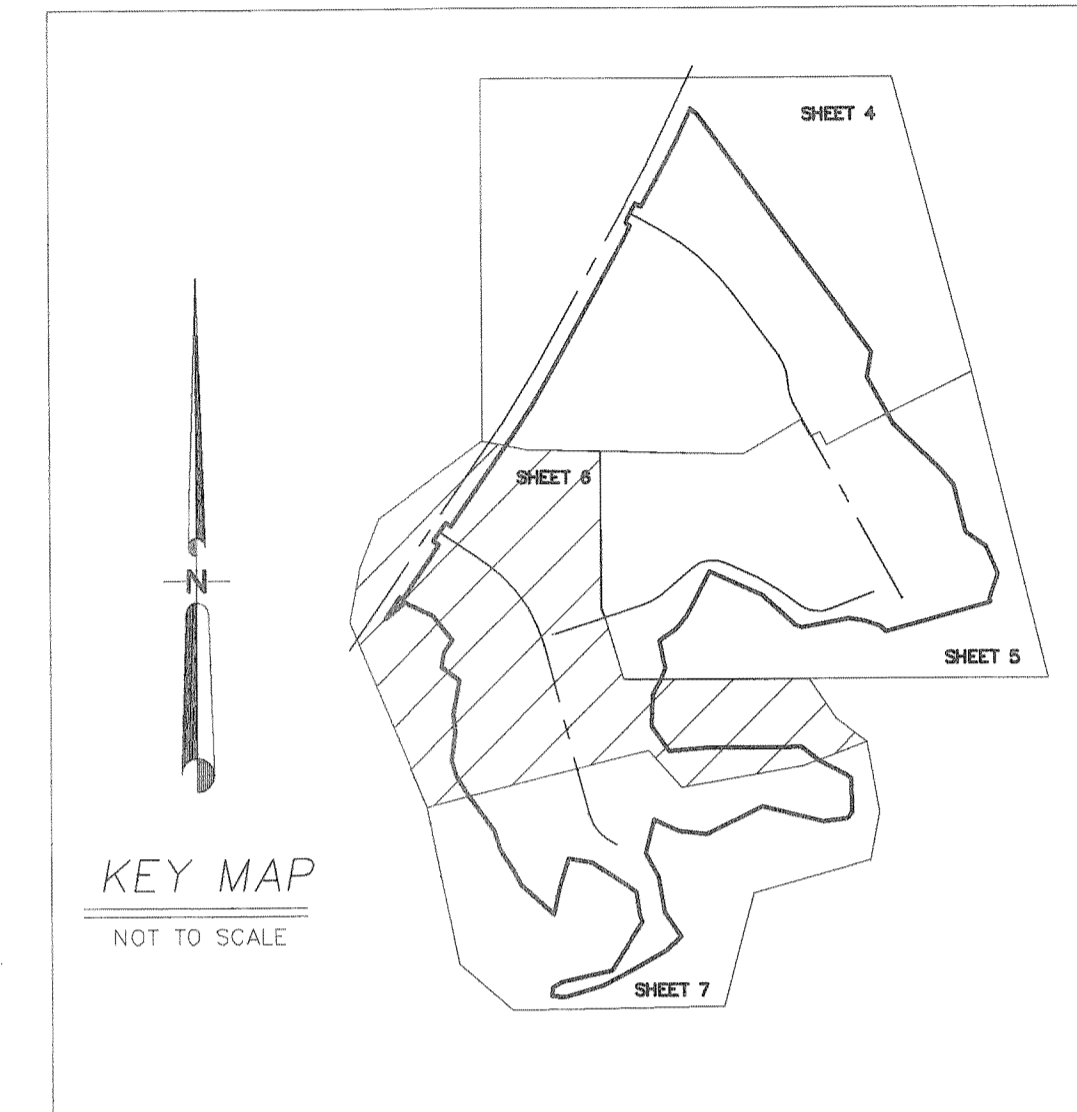
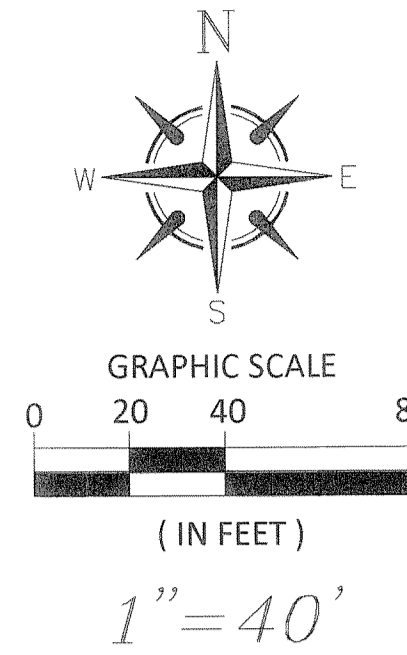

CURVE TABLE					
CURVE #	LENGTH	RADIUS	DELTA	CHORD LENGTH	CHD. BEARING
C1	25.25	525.00	002°45'22"	25.25	N59°38'04"W
C2	141.27	1540.00	005°15'22"	141.22	N26°21'34"E
C3	50.01	525.00	005°27'28"	49.99	N55°31'39"W
C4	50.03	525.00	005°27'37"	50.01	N50°04'07"W
C5	50.03	525.00	005°27'37"	50.01	N44°36'30"W
C6	50.02	525.00	005°27'30"	50.00	N39°08'56"W
C7	2.59	525.00	000°16'56"	2.59	N36°16'42"W
C8	22.84	125.00	010°28'02"	22.80	N30°54'13"W
C9	49.87	125.00	022°51'37"	49.54	N14°14'24"W
C10	4.89	125.00	002°14'28"	4.89	N01°41'22"W
C11	62.13	100.00	035°35'52"	61.14	N18°20'18"W
C12	37.42	75.00	028°35'01"	37.03	S14°46'56"E
C13	49.80	100.00	028°32'04"	49.29	S14°48'24"E
C14	1.74	27.50	003°37'16"	1.74	S30°53'04"E
C15	36.05	50.00	041°18'19"	35.27	N55°46'44"W
C16	47.52	50.00	054°27'35"	45.76	N07°53'48"W
C17	39.11	50.00	044°49'01"	38.12	N41°44'30"E
C21	52.63	125.00	024°07'25"	52.24	S17°00'44"E
C22	9.62	125.00	004°24'39"	9.62	S02°44'41"E
C23	46.60	75.00	035°33'52"	45.85	N18°20'18"W
C24	38.61	475.00	004°39'27"	38.60	N38°27'58"W
C25	66.90	475.00	008°04'11"	66.85	N44°49'46"W
C26	66.90	475.00	008°04'11"	66.85	N52°53'58"W
C27	33.81	475.00	004°04'41"	33.80	N58°58'24"W
C28	25.27	355.00	004°04'41"	25.26	N58°58'24"W
C29	50.00	355.00	008°04'11"	49.96	N52°53'58"W
C30	50.00	355.00	008°04'11"	49.96	N44°49'46"W
C31	28.86	355.00	004°39'27"	28.85	N38°27'58"W
C32	37.09	470.00	004°31'19"	37.08	N53°16'17"W
C33	64.74	470.00	007°53'31"	64.69	N47°03'52"W
C34	64.74	470.00	007°53'31"	64.69	N39°10'21"W
C35	64.74	470.00	007°53'31"	64.69	N31°16'49"W
C36	64.74	470.00	007°53'31"	64.69	N23°23'18"W
C37	12.06	470.00	001°28'11"	12.06	N15°25'59"W
C38	34.84	50.00	039°55'44"	34.14	N77°11'31"W
C39	36.65	27.50	076°20'59"	33.99	S58°58'53"E
C40	8.00	75.00	006°06'30"	7.99	S17°45'09"E
C41	95.94	100.00	054°58'07"	92.30	S42°10'57"E
C42	8.98	350.00	001°28'11"	8.98	N15°25'59"W
C43	48.21	350.00	007°53'31"	48.17	N23°23'18"W
C44	48.21	350.00	007°53'31"	48.17	N31°16'49"W
C45	48.21	350.00	007°53'31"	48.17	N39°10'21"W
C46	48.21	350.00	007°53'31"	48.17	N47°03'52"W
C47	27.62	350.00	004°31'19"	27.62	N53°16'17"W
C48	46.46	300.00	008°52'23"	46.41	N51°05'45"W
C49	81.08	300.00	015°29'07"	80.83	N38°55'00"W
C50	81.08	300.00	015°29'07"	80.83	N23°25'53"W
C51	5.19	300.00	000°58'25"	5.19	N15°11'37"W
C52	4.20	125.00	001°55'30"	4.20	S15°39'39"E
C53	57.49	125.00	026°21'10"	56.99	S29°47'59"E
C54	5.41	27.50	011°15'43"	5.40	N37°20'42"W
C55	11.60	27.50	024°09'34"	11.51	N19°38'04"W
C56	200.43	50.00	229°40'22"	90.75	N57°36'32"E
C57	227.93	525.00	024°52'30"	226.14	N48°34'29"W
C58	77.66	125.00	035°55'52"	76.42	N18°20'18"W
C59	117.05	50.00	134°08'01"	92.10	S48°46'59"E
C60	239.73	50.00	274°42'55"	67.74	N60°55'34"E
C61	10.45	27.50	021°46'57"	10.39	N07°23'33"E
C62	12.28	27.50	025°34'30"	12.17	N16°17'11"W
C63	22.73	27.50	047°21'28"	22.08	N05°23'42"W
C64	62.25	125.00	028°32'04"	61.61	S14°48'24"E
C65	206.22	475.00	024°52'30"	204.61	N48°34'29"W
C66	154.12	355.00	024°52'30"	152.92	N48°34'29"W
C67	286.05	470.00	036°05'24"	291.18	N37°29'15"W
C68	249.44	350.00	040°50'02"	244.20	N35°06'55"W
C70	235.27	50.00	269°36'05"	70.96	N37°38'40"E
C71	17.00	27.50	035°25'17"	16.73	N25°15'56"W
C72	61.69	125.00	028°16'40"	61.07	S28°50'14"E
C73	213.81	300.00	040°50'02"	209.31	N35°06'55"W
C74	217.08	500.00	024°52'30"	215.38	N48°34'29"W
C75	66.15	70.00	056°35'58"	66.37	S82°08'15"E
C76	80.39	70.00	065°47'47"	76.04	S82°33'58"W
C77	49.15	125.00	022°31'36"	48.83	N60°55'53"E
C78	231.62	325.00	040°50'02"	226.75	N35°06'55"W
C79	10.00	350.00	001°38'14"	10.00	N18°37'26"W
C80	10.00	350.00	001°38'14"	10.00	N16°59'12"W
C81	33.79	50.00	038°43'16"	33.15	S01°04'36"E
C82	4.75	9.00	030°13'01"	4.69	N70°38'27"W
C83	2.64	5.00	030°13'01"	2.61	N70°38'27"W
C84	4.75	9.00	030°13'01"	4.69	N40°25'26"W
C85	2.64	5.00	030°13'01"	2.61	N40°25'26"W
C86	4.62	9.00	029°23'15"	4.57	N75°42'22"W
C87	2.56	5.00	029°23'15"	2.54	N75°42'22"W
C88	4.67	9.00	029°45'26"	4.62	N46°08'02"W
C89	2.60	5.00	029°45'27"	2.57	N46°08'01"W
C91	0.25	75.00	000°11'28"	0.25	N36°02'30"W
C92	20.99	27.50	043°44'12"	20.49	S54°33'48"E

LINE TABLE		
LINE #	DIRECTION	LENGTH
L1	N55°31'56"W	8.61'
L2	N85°44'57"W	7.79'
L3	N55°31'56"W	17.62'
L4	N55°31'56"W	8.61'
L5	N25°18'56"W	7.79'
L6	N55°31'56"W	17.62'
L7	N61°00'45"W	8.12'
L8	S89°36'00"W	7.79'
L9	N61°00'45"W	18.22'
L10	N61°00'45"W	9.00'
L11	N31°15'18"W	7.82'
L12	N61°00'45"W	17.26'

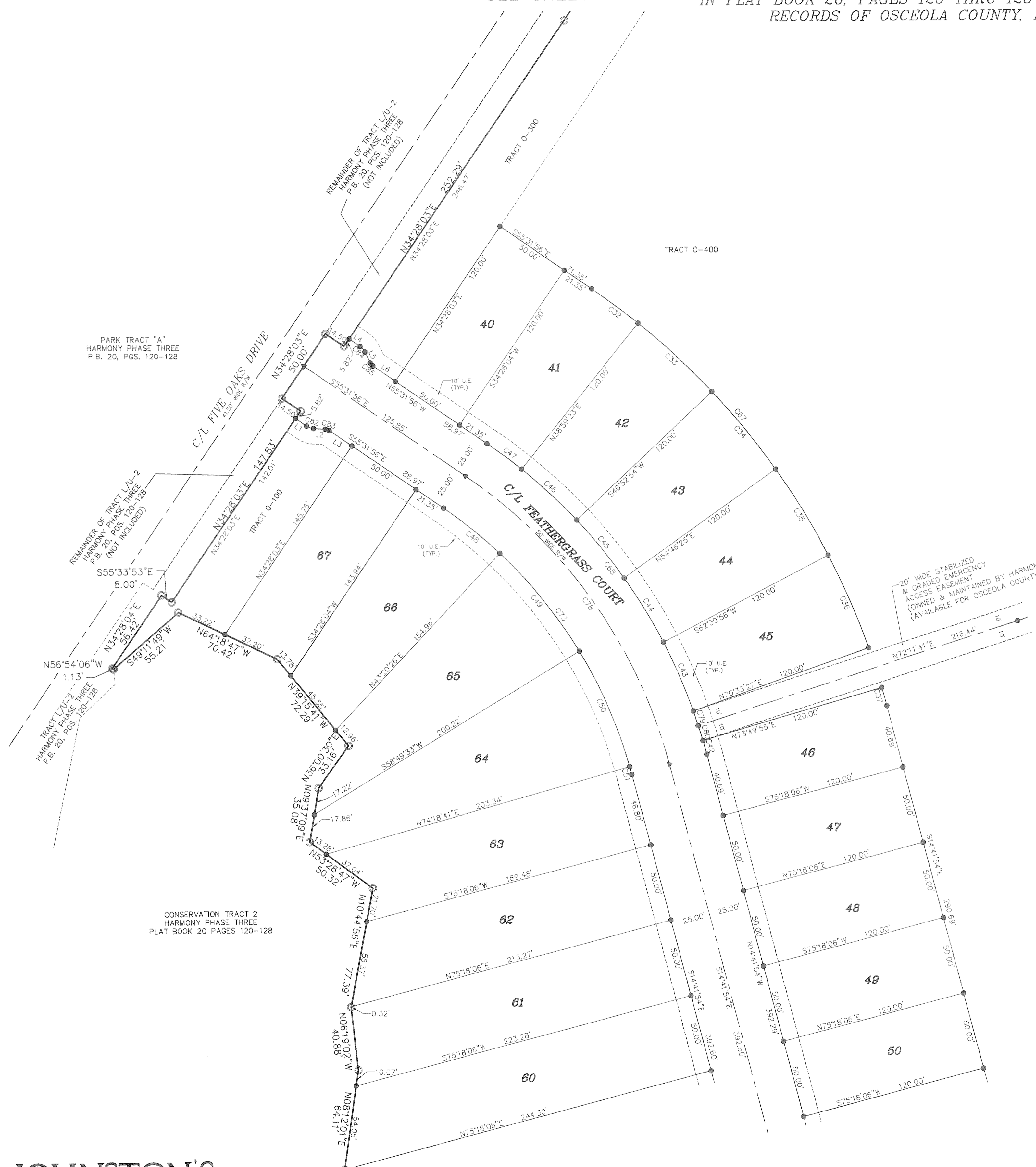

SEE SHEET 5 OF 7

SEE SHEET 7 OF 7

NOTE: SEE SHEETS 1-3 FOR LEGAL DESCRIPTION, NOTES, EASEMENTS & LEGEND

**JOHNSTON'S**  
SURVEYING INC.  
900 Shady Lane, Kissimmee, Florida 34744-8695  
Tel. (407) 847-2179 Fax (407) 847-6140

# HARMONY NEIGHBORHOOD O-1

SECTION 29, TOWNSHIP 26 SOUTH, RANGE 32 EAST,  
OSCEOLA COUNTY, FLORIDA  
BEING A REPLAT OF TRACT M AND A PORTION OF TRACT  
L/U-2, HARMONY PHASE THREE, AS FILED AND RECORDED  
IN PLAT BOOK 20, PAGES 120 THRU 128 OF THE PUBLIC  
RECORDS OF OSCEOLA COUNTY, FLORIDA.

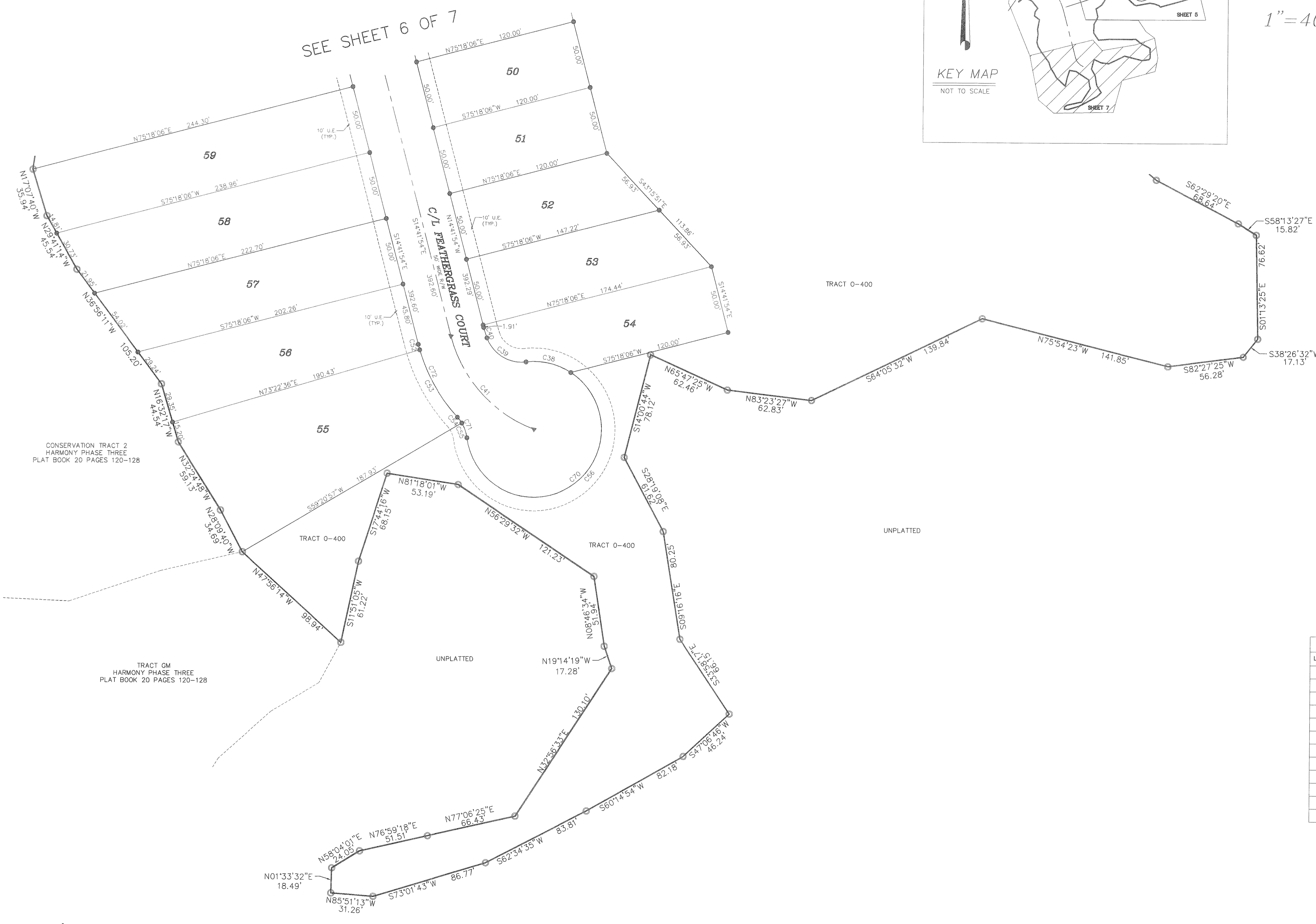
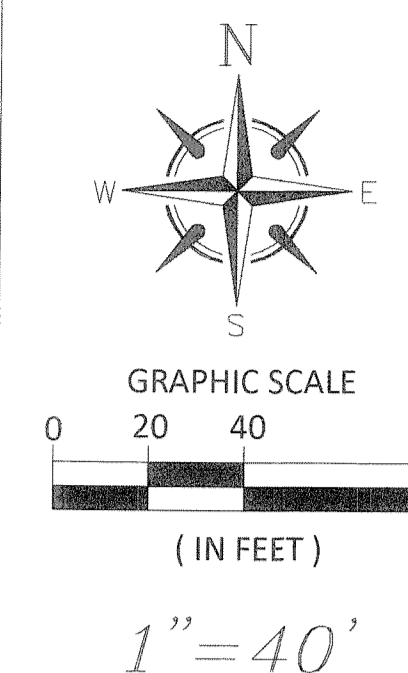
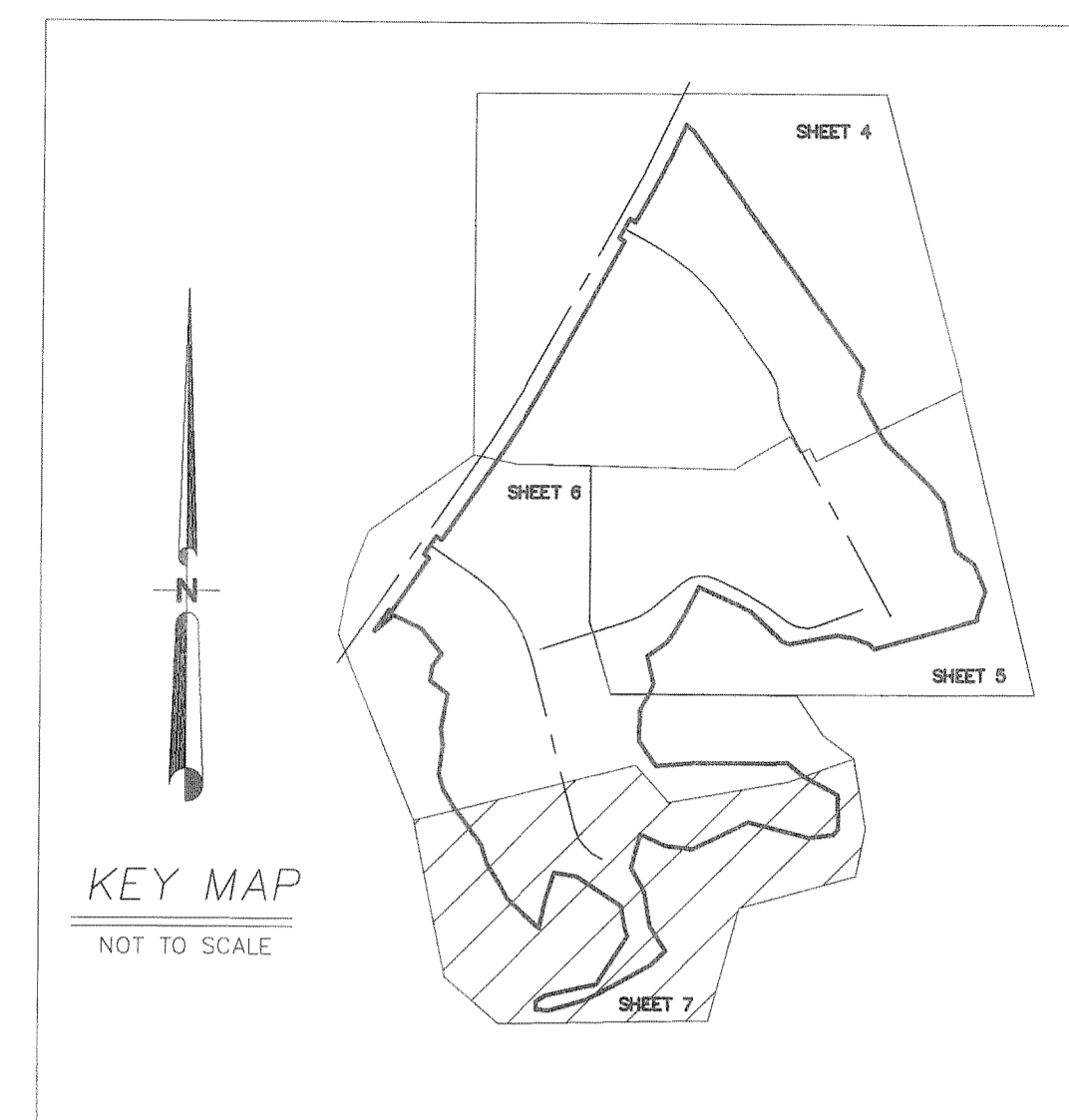

CURVE TABLE					
CURVE #	LENGTH	RADIUS	DELTA	CHORD LENGTH	CHD. BEARING
C1	25.25	525.00	002°45'22"	25.25	N59°38'04"W
C2	141.27	1540.00	005°15'22"	141.22	N26°21'34"E
C3	50.01	525.00	005°27'28"	49.99	N55°31'39"W
C4	50.03	525.00	005°27'37"	50.01	N50°04'07"W
C5	50.03	525.00	005°27'37"	50.01	N44°36'30"W
C6	50.02	525.00	005°27'30"	50.00	N39°08'56"W
C7	2.59	525.00	000°16'56"	2.59	N36°16'42"W
C8	22.84	125.00	010°28'02"	22.80	N30°54'13"W
C9	49.87	125.00	022°51'37"	49.54	N14°14'24"W
C10	4.89	125.00	002°14'28"	4.89	N01°41'22"W
C11	62.13	100.00	035°35'52"	61.14	N18°20'18"W
C12	37.42	75.00	028°35'01"	37.03	S14°46'56"E
C13	49.80	100.00	028°32'04"	49.29	S14°48'24"E
C14	1.74	27.50	003°37'16"	1.74	S30°53'04"E
C15	36.05	50.00	041°18'19"	35.27	N55°46'44"W
C16	47.52	50.00	054°27'35"	45.76	N07°53'48"W
C17	39.11	50.00	044°49'01"	38.12	N41°44'30"E
C21	52.63	125.00	024°07'25"	52.24	S17°00'44"E
C22	9.62	125.00	004°24'39"	9.62	S02°44'41"E
C23	46.60	75.00	035°35'52"	45.85	N18°20'18"W
C24	38.61	475.00	004°39'27"	38.60	N38°27'58"W
C25	66.90	475.00	008°04'11"	66.85	N44°49'46"W
C26	66.90	475.00	008°04'11"	66.85	N52°53'58"W
C27	33.81	475.00	004°04'41"	33.80	N58°58'24"W
C28	25.27	355.00	004°04'41"	25.26	N58°58'24"W
C29	50.00	355.00	008°04'11"	49.96	N52°53'58"W
C30	50.00	355.00	008°04'11"	49.96	N44°49'46"W
C31	28.86	355.00	004°39'27"	28.85	N38°27'58"W
C32	37.09	470.00	004°31'19"	37.08	N53°16'17"W
C33	64.74	470.00	007°53'31"	64.69	N47°03'52"W
C34	64.74	470.00	007°53'31"	64.69	N39°10'21"W
C35	64.74	470.00	007°53'31"	64.69	N31°16'49"W
C36	64.74	470.00	007°53'31"	64.69	N23°23'18"W
C37	12.06	470.00	001°28'11"	12.06	N15°25'59"W
C38	34.84	50.00	039°55'44"	34.14	N77°11'31"W
C39	36.65	27.50	076°20'59"	33.99	S58°58'53"E
C40	8.00	75.00	006°06'30"	7.99	S17°45'09"E
C41	95.94	100.00	054°58'07"	92.30	S42°10'57"E
C42	8.98	350.00	001°28'11"	8.98	N15°25'59"W
C43	48.21	350.00	007°53'31"	48.17	N23°23'18"W
C44	48.21	350.00	007°53'31"	48.17	N31°16'49"W
C45	48.21	350.00	007°53'31"	48.17	N39°10'21"W
C46	48.21	350.00	007°53'31"	48.17	N47°03'52"W
C47	27.62	350.00	004°31'19"	27.62	N53°16'17"W
C48	46.46	300.00	008°52'23"	46.41	N51°05'45"W
C49	81.08	300.00	015°29'07"	80.83	N38°55'00"W
C50	81.08	300.00	015°29'07"	80.83	N23°25'53"W
C51	5.19	300.00	000°59'25"	5.19	N15°11'37"W
C52	4.20	125.00	001°55'30"	4.20	S15°39'39"E
C53	57.49	125.00	026°21'10"	56.99	S29°47'59"E
C54	5.41	27.50	011°15'43"	5.40	N37°20'42"W
C55	11.60	27.50	024°09'34"	11.51	N19°38'04"W
C56	200.43	50.00	229°40'22"	90.75	N57°36'32"E
C57	227.93	525.00	024°52'30"	226.14	N48°34'29"W
C58	77.66	125.00	035°35'52"	76.42	N18°20'18"W
C59	117.05	50.00	134°08'01"	92.10	S48°46'59"E
C60	239.73	50.00	274°42'55"	67.74	N60°55'34"E
C61	10.45	27.50	021°46'57"	10.39	N07°23'33"E
C62	12.28	27.50	025°34'30"	12.17	N16°17'11"W
C63	22.73	27.50	047°21'28"	22.09	N05°23'42"W
C64	62.25	125.00	028°32'04"	61.61	S14°48'24"E
C65	206.22	475.00	024°52'30"	204.61	N48°34'29"W
C66	154.12	355.00	024°52'30"	152.92	N48°34'29"W
C67	286.05	470.00	036°05'24"	281.18	N37°29'15"W
C68	249.44	350.00	040°50'02"	244.20	N35°06'55"W
C70	235.27	50.00	269°36'05"	70.96	N37°38'40"E
C71	17.00	27.50	035°25'17"	16.73	N25°15'56"W
C72	61.69	125.00	028°16'40"	61.07	S28°30'14"E
C73	213.81	300.00	040°50'02"	209.31	N35°06'55"W
C74	217.08	500.00	024°52'30"	215.38	N48°34'29"W
C75	69.15	70.00	056°35'59"	66.37	S82°08'15"E
C76	80.39	70.00	065°47'47"	76.04	S82°33'58"W
C77	49.15	125.00	022°31'36"	48.83	N60°55'53"E
C78	231.62	325.00	040°50'02"	226.75	N35°06'55"W
C79	10.00	350.00	001°38'14"	10.00	N18°37'26"W
C80	10.00	350.00	001°38'14"	10.00	N16°59'12"W
C81	33.79	50.00	038°43'16"	33.15	S01°04'36"E
C82	4.75	9.00	030°13'01"	4.69	N70°38'27"W
C83	2.64	5.00	030°13'01"	2.61	N70°38'27"W
C84	4.75	9.00	030°13'01"	4.69	N40°25'26"W
C85	2.64	5.00	030°13'01"	2.61	N40°25'26"W
C86	4.62	9.00	029°23'15"	4.57	N75°42'22"W
C87	2.56	5.00	029°23'15"	2.54	N75°42'22"W
C88	4.67	9.00	029°45'26"	4.62	N46°08'02"W
C89	2.60	5.00	029°45'27"	2.57	N46°08'01"W
C91	0.25	75.00	000°11'28"	0.25	N36°02'30"W
C92	20.99	27.50	043°44'12"	20.49	S54°33'48"E

LINE TABLE		
LINE #	DIRECTION	LENGTH
L1	N55°31'56"W	8.61'
L2	N85°44'57"W	7.79'
L3	N55°31'56"W	17.62'
L4	N55°31'56"W	8.61'
L5	N25°18'56"W	7.79'
L6	N55°31'56"W	17.62'
L7	N61°00'45"W	8.12'
L8	S89°36'00"W	7.79'
L9	N61°00'45"W	18.22'
L10	N61°00'45"W	9.00'
L11	N31°15'18"W	7.82'
L12	N61°00'45"W	17.26'

**JOHNSTON'S**  
SURVEYING INC.  
900 Shady Lane, Kissimmee, Florida 34744-8695  
Tel. (407) 847-2179 Fax (407) 847-6140

NOTE: SEE SHEETS 1-3 FOR LEGAL DESCRIPTION, NOTES, EASEMENTS & LEGEND